



## HAKKIMIZDA

VTEKE Elektrik olarak endüstriyel elektrik malzemeleri üreticisi olup birçok farklı alanda ürünler imal etmekteyiz. 35 ülkeden fazla noktaya ihracat yapmakta, gerek yurt içi gerekse yurt dışında birçok prestijli projeye ürün tedariki sağlamaktayız.

Sürdürülebilir kalite prensiplerimizle ulusal ve uluslararası TSE, TUV, CE, ISO, EAC, SABER, Sanayi ve Teknoloji Bakanlığı, Ölçü Aletleri Ulusal Tip Onay Belgesi (Mühür), CMIM gibi belgeler başta olmak üzere birçok sertifikasyona sahibiz.

Her geçen gün genişlemekte olan ürün gamımızla başta akım trafoları, analog göstergeler, kaçak akım koruma cihazları, minyatür röleler, akü şarj aletleri, güç kaynakları, sigorta çeşitleri, daha fazlası ve güçlü stok yapımızla müşterilerimize hizmet sunmaktayız.

Yukarıda bahsi geçen ürünlerin yanında müşterilerimizin taleplerine özel ürünler üreterek kaliteyi ve hızlı çözümleri sağlama noktasında süreçlere katkı sağlamaktayız.

Dünyanın her yerinden gelebilecek taleplere yönelik gerek geniş ürün gamımızla gerekse teknik desteğimizle her zaman hizmet sağlamaktan mutluluk duyarız.

## **İÇİNDEKİLER**

|   |    |
|---|----|
| KAÇAK AKIM RÖLELERİ VE ÇEKİRDEK DENGESİ AKIM TRAFOLARI (TROİDAL)..... | 4  |
| AKIM TRAFOLARI.....   | 7  |
| RÖLE VE SOKETLER.....   | 17 |
| SİLİNDİRİK SİGORTA YUVALARI VE BUŞONLARI.....                         | 21 |
| ANALOG ÖLÇÜ ALETLERİ.....   | 24 |
| CAM SİGORTALAR.....   | 28 |
| AKIM TRANSDÜSERİ.....   | 30 |
| AKÜ ŞARJ ALETİ VE GÜÇ KAYNAKLARI.....                                 | 32 |
| DİJİTAL ÖLÇÜ ALETLERİ.....  | 33 |
| ZAMAN RÖLELERİ.....   | 37 |
| KUMANDA RÖLELERİ.....   | 40 |
| KORUMA RÖLELERİ.....  | 42 |
| BUTON SERİSİ VE AKSESUARLARI.....                                     | 45 |
| İŞ-GÜÇ ZAMAN SAATLERİ.....  | 51 |

# KAÇAK AKIM RÖLELERİ VE ÇEKİRDEK DENGESİ AKIM TRAFOLARI (TROIĐAL)

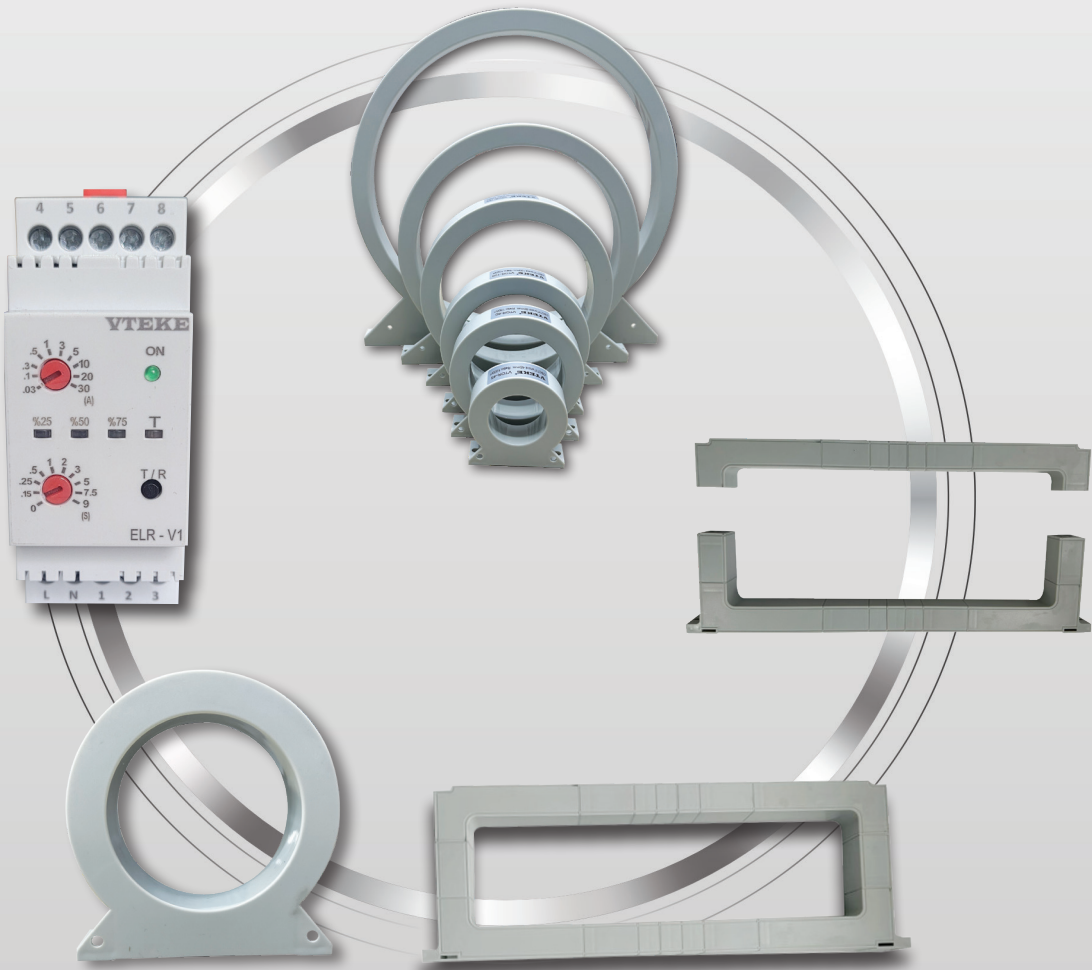

**VTEKE®**

# KAÇAK AKIM RÖLESİ

## ELR-V1

### TEKNİK ÖZELLİKLER

| PARAMETRE                        | DEĞER  |
|----------------------------------|--|
| Standartlar                      | IEC 60947-2 / IEC 60947-2 LV directive 2014/35/EU EMC directive 2014/30/EU   |
| Besleme Voltajı                  | 50-270 VAC/DC  |
| Frekans                          | 50/60 Hz   |
| Çalışma Gücü                     | 2VA  |
| Çekirdek Denge Akım Trafosu Tipi | Sadece VTEKE V-XXX Serileri kullanılabilir   |
| Kaçak Akım Rölesi Tipi           | A Tipi   |
| Kaçak Akım Trip Seviyesi         | 30mA, 100mA, 300mA, 500mA 1A, 3A, 5A, 10A, 20A, 30A  |
| Gecikme zamanı                   | 0 (<40 msec), 0.15, 0.25, 0.50 1, 2, 3, 5, 7, 9 sec  |
| Reset zamanı                     | 1 sec  |
| Toroid Trafo fonksyonu           | Toroid Trafo kısa devre veya mevcut değil  |
| Doğruluk                         | Ayarlanan Trip Akım +- %5<br>Ayarlanan Gecikme Zaman +- %5<br>+ 0 (<40 msn)  |
| Test/Reset İmkanı                | Ön taraf (Buton) Uzaktan Terminal kontakları ile   |
| Reset Limit Seviyesi             | Çekirdek denge akım trafosu çıkış akımı ayarlanan trip akım seviyesinin %90'una düşüğünde reset fonksiyonu aktif olur            |
| Trip Röle                        | 1 NO +1 NC (Kontakt kapasitesi 10A)  |
| Sıcaklık                         | Çalışma -10C to +70C Depolama -25C to +70C   |
| Çalışma Yüksekliği               | 2000m  |
| Montaj                           | DIN Ray 35mm   |
| Terminals                        | Vidalı klemens. Kablo kesiti AWG30 ve AWG12 ile arası (0.06 mm <sup>2</sup> 'den 3.3mm <sup>2</sup> 'a kadar) standart veya sert |
| Kasa materyeli                   | ABS  |
| Ağırlık                          | 115 gr   |
| Ebatlar                          | 30x90x58   |

### ÖZELLİKLER

**Kaçak akım rölesi (ELR-V1)**, yük ve hatlar kaçak akıma karşı korumak için modüler tipte tasarlanmıştır. ELR-V1, ayarlanabilir gecikme zamanı ve ayarlanabilir kaçak akım esigi (trip akımı) sayesinde topraklama ve yalıtım hatalarını önlemek için ihtiyaç duyulan çeşitli uygulamalarda kullanılabilir.

- Kompakt Kasa
- 30mA to 30A aralığında ayarlanabilir kaçak akım eşığı
- 0 - 9 saniye aralığında ayarlanabilir gecikme zamanı
- 1 faz (Faz, Nötr), 3 faz (3 Faz veya 3 Faz + Nötr) sistemler ile uyumlu
- Belirlenen kaçak akım eşığına göre kaçak akım seviyesinin %25, %50, %75 ve %100 (Trip akımı) ledler ile gösterilmesi
- Cihaz ön paneli üzerinden test/reset butonu ile veya cihaz terminal bağlantısı kullanılarak uzaktan test/reset imkanı
- Cihaz girişinde CBCT bağlı olmadığı ve kısa devre olduğunda uyan verilmesi



## BAĞLANTI ŞEMASI

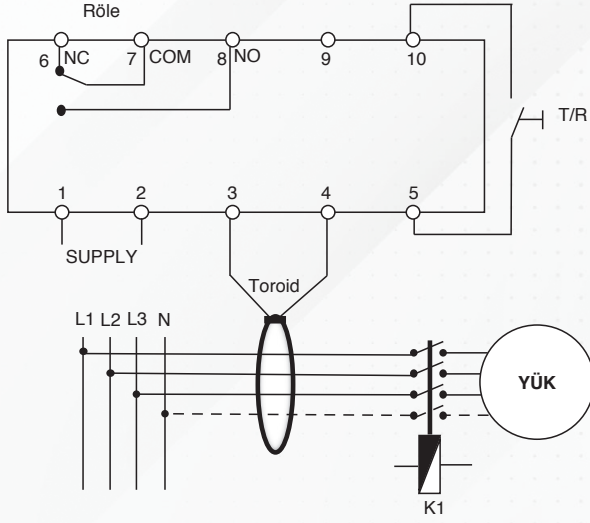

## LED GÖSTERME DURUMU

| DURUM                          | ON | 25%   | 50%   | 75%   | TRIP  |
|--------------------------------|----|-------|-------|-------|-------|
| Cihaz ON                       | ON | OFF   | OFF   | OFF   | OFF   |
| Trip Akımı Aşılış              | ON | ON    | ON    | ON    | ON    |
| CBCT mevcut değil / kısa devre | ON | BLINK | BLINK | BLINK | BLINK |
| %25 Kaçak Akımı                | ON | ON    | OFF   | OFF   | OFF   |
| %50 Kaçak Akımı                | ON | ON    | ON    | OFF   | OFF   |
| %70 Kaçak Akımı                | ON | ON    | ON    | ON    | OFF   |

## TOROID AKIM TRAFOSU

## VTOR SERİSİ

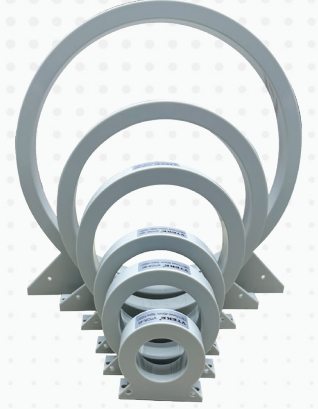

## ÖZELLİKLER

- VTOR Serisi toroid akım trafolar pano içi kullanımlara uygundur.
- Epoksi reçine ile kaplanmış olup bu özellikleri ile sayesinde yüksek hassasiyet ve stabil çalışmaya sahiptir.
- 45mm - 500 mm aralığında çeşitli delik çaplarına sahiptir.

## TEKNİK ÖZELLİKLER

| PARAMETRE         | DEĞER         |
|-------------------|---------------|
| Giriş Voltajı     | 100-240VAC/DC |
| Frekans           | 50/60 Hz      |
| Doğruluk Sınıfı   | 1000/1        |
| Accuracy Class    | 0.5           |
| Test Voltajı      | 3kV AC, 1min  |
| İzolasyon Direnci | DC500V/100MΩ  |
| Çalışma Sıcaklığı | -15C to +45C  |

## FİYAT LİSTESİ

| KAÇAK AKIM RÖLESİ VE TORIOD |                                    |            |
|-----------------------------|------------------------------------|------------|
| ELR-V1                      | KAÇAK AKIM RÖLESİ 30mA - 30A       | \$87,00    |
| VTOR-45                     | TOROIDAL AKIM TRAFOSU 45MM         | \$22,00    |
| VTOR-80                     | TOROIDAL AKIM TRAFOSU 80MM         | \$34,00    |
| VTOR-100                    | TOROIDAL AKIM TRAFOSU 100MM        | \$52,00    |
| VTOR-150                    | TOROIDAL AKIM TRAFOSU 150MM        | \$98,00    |
| VTOR-210                    | TOROIDAL AKIM TRAFOSU 210MM        | \$120,00   |
| VTOR-310                    | TOROIDAL AKIM TRAFOSU 310MM        | \$270,00   |
| VDIK-36                     | Dikdörtgen CBCT 360X10             | \$700,00   |
| VDIK-50                     | Dikdörtgen CBCT 500X10             | \$1.000,00 |
| VAYR-36                     | Ayrılabilir Dikdörtgen CBCT 360X10 | \$800,00   |
| VAYR-50                     | Ayrılabilir Dikdörtgen CBCT 500X10 | \$1.100,00 |

## VDIK SERİSİ

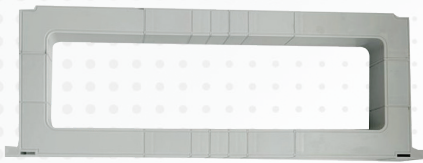

## VAYR SERİSİ



# AKIM TRAFOLARI



**VTEKE®**

**XX-XXX-XXXX-X-X-XX**

**AKIM TRAFOSU KODLAMA ÇİZELGESİ**

| SERİ KODU | DELİK ÇAPI | PRİMER (A) | SEKONDER (A) | CLASS |       | VA DEĞERİ |           |
|-----------|------------|------------|--------------|-------|-------|-----------|-----------|
|           |            |            |              | KOD   | CLASS | KOD       | VA DEĞERİ |
| CK        | 20         | 5          | 1            | 1     | 01    | 1         |           |
| TK        | 30S        | -          | 5            | 2     | 0.5   | 02        | 1.5       |
| DK        | 30         | -          |              | 3     | 0.5S  | 03        | 2.5       |
| BK        | 40         | -          |              | 4     | 0.1   | 04        | 3.75      |
| BK1C      | 60         | -          |              | 5     | 0.1S  | 05        | 5         |
| SK        | 80         | 6300       |              | 6     | 0.2   | 06        | 7.5       |
| MSK       | 100        |            |              | 7     | 0.2S  | 07        | 10        |
| RK        | 120        |            |              | 8     | 5     | 08        | 12.5      |
|           | 125        |            |              | 9     | 3     | 09        | 15        |
|           |            |            |              |       |       | 10        | 20        |
|           |            |            |              |       |       | 11        | 25        |
|           |            |            |              |       |       | 12        | 30        |
|           |            |            |              |       |       | 13        | 40        |
|           |            |            |              |       |       | 14        | 50        |
|           |            |            |              |       |       | 15        | 60        |

Örnek Kodlama: TK30 500/5A, CL.1.0, 7.5VA  
 Örnek Kod: TK305005106

**MONTAJ OPSİYONLARI**

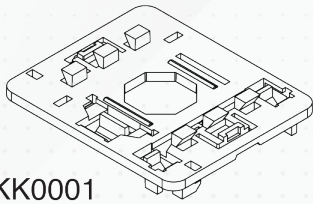

KK0001

DIN Ray Tipi Sabitleme Klipsi

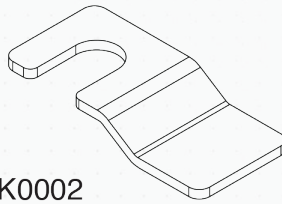

KK0002

Metal Sabitleyici

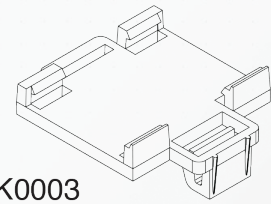

KK0003

DIN Ray Tipi Sabitleme Klipsi



**FİYAT LİSTESİ**
**AKIM TRAFOLARI**
**DELİKLİ TİP AKIM TRAFOSU**

|              |   |         |
|--------------|---|---------|
| CK20405901   | AKIM TRAFOSU 40/5A, 20MM, SINIF 3, 1VA      | \$10,00 |
| CK20505901   | AKIM TRAFOSU 50/5A, 20MM, SINIF 3, 1VA      | \$10,00 |
| CK20605101   | AKIM TRAFOSU 60/5A, 20MM, SINIF 1, 1VA      | \$10,00 |
| CK20755102   | AKIM TRAFOSU 75/5A, 20MM, SINIF 1, 1.5VA    | \$10,00 |
| CK20805102   | AKIM TRAFOSU 80/5A, 20MM, SINIF 1, 1.5VA    | \$10,00 |
| CK201005102  | AKIM TRAFOSU 100/5A, 20MM, SINIF 1, 1.5VA   | \$10,00 |
| CK201255103  | AKIM TRAFOSU 125/5A, 20MM, SINIF 1, 2.5VA   | \$10,00 |
| CK201505103  | AKIM TRAFOSU 150/5A, 20MM, SINIF 1, 2.5VA   | \$10,00 |
| CK201605103  | AKIM TRAFOSU 160/5A, 20MM, SINIF 1, 2.5VA   | \$10,00 |
| CK202005103  | AKIM TRAFOSU 200/5A, 20MM, SINIF 1, 2.5VA   | \$10,00 |
| CK202505103  | AKIM TRAFOSU 250/5A, 20MM, SINIF 1, 2.5VA   | \$10,00 |
| CK203005103  | AKIM TRAFOSU 300/5A, 20MM, SINIF 1, 2.5VA   | \$10,00 |
| CK201005202  | AKIM TRAFOSU 100/5A, 20MM, SINIF 0.5, 1.5VA | \$10,50 |
| CK201255202  | AKIM TRAFOSU 125/5A, 20MM, SINIF 0.5, 1.5VA | \$10,50 |
| CK201505202  | AKIM TRAFOSU 150/5A, 20MM, SINIF 0.5, 1.5VA | \$10,50 |
| CK201605202  | AKIM TRAFOSU 160/5A, 20MM, SINIF 0.5, 1.5VA | \$10,50 |
| TK30N605902  | AKIM TRAFOSU 60/5A, 30MM, SINIF 3, 1.5VA    | \$10,50 |
| TK30N755902  | AKIM TRAFOSU 75/5A, 30MM, SINIF 3, 1.5VA    | \$10,50 |
| TK30N805902  | AKIM TRAFOSU 80/5A, 30MM, SINIF 1, 1.5VA    | \$10,50 |
| TK30N1005102 | AKIM TRAFOSU 100/5A, 30MM, SINIF 1, 1.5VA   | \$10,50 |
| TK30N1255102 | AKIM TRAFOSU 125/5A, 30MM, SINIF 1, 1.5VA   | \$10,50 |
| TK30N1505103 | AKIM TRAFOSU 150/5A, 30MM, SINIF 1, 2.5VA   | \$10,50 |
| TK30N1605103 | AKIM TRAFOSU 160/5A, 30MM, SINIF 1, 2.5VA   | \$10,50 |
| TK30N2005103 | AKIM TRAFOSU 200/5A, 30MM, SINIF 1, 2.5VA   | \$10,50 |
| TK30N2505103 | AKIM TRAFOSU 250/5A, 30MM, SINIF 1, 2.5VA   | \$10,50 |
| TK30N3005103 | AKIM TRAFOSU 300/5A, 30MM, SINIF 1, 2.5VA   | \$10,50 |
| TK30N4005103 | AKIM TRAFOSU 400/5A, 30MM, SINIF 1, 2.5VA   | \$10,50 |
| TK30N5005103 | AKIM TRAFOSU 500/5A, 30MM, SINIF 1, 2.5VA   | \$10,50 |
| TK30N6005103 | AKIM TRAFOSU 600/5A, 30MM, SINIF 1, 2.5VA   | \$10,50 |
| TK30N1505203 | AKIM TRAFOSU 150/5A, 30MM, SINIF 0.5, 2.5VA | \$11,00 |
| TK30N1605203 | AKIM TRAFOSU 160/5A, 30MM, SINIF 0.5, 2.5VA | \$11,00 |
| TK30N2005203 | AKIM TRAFOSU 200/5A, 30MM, SINIF 0.5, 2.5VA | \$11,00 |
| TK30N2505203 | AKIM TRAFOSU 250/5A, 30MM, SINIF 0.5, 2.5VA | \$11,00 |
| TK30N3005203 | AKIM TRAFOSU 300/5A, 30MM, SINIF 0.5, 2.5VA | \$11,00 |
| TK30N4005203 | AKIM TRAFOSU 400/5A, 30MM, SINIF 0.5, 2.5VA | \$11,00 |
| TK30N5005203 | AKIM TRAFOSU 500/5A, 30MM, SINIF 0.5, 2.5VA | \$11,00 |
| TK30N6005203 | AKIM TRAFOSU 600/5A, 30MM, SINIF 0.5, 2.5VA | \$11,00 |

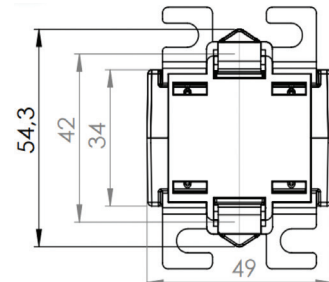
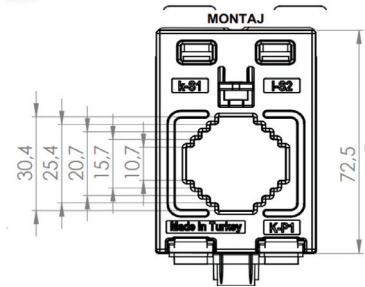
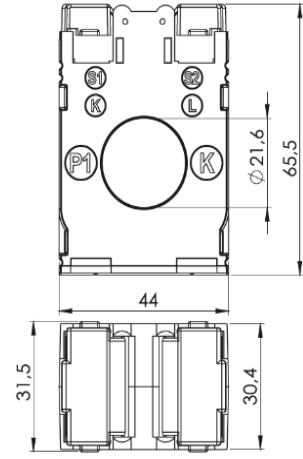

**FİYAT LİSTESİ**
**DELİKLİ TİP AKIM TRAFOSU**

|              |  |         |
|--------------|--|---------|
| TK30405901   | AKIM TRAFOSU 40/5A, 30MM, SINIF 3, 1VA       | \$12,86 |
| TK30505101   | AKIM TRAFOSU 50/5A, 30MM, SINIF 1, 1VA       | \$16,00 |
| TK30605101   | AKIM TRAFOSU 60/5A, 30MM, SINIF 1, 1VA       | \$14,00 |
| TK30805102   | AKIM TRAFOSU 80/5A, 30MM, SINIF 1, 1.5VA     | \$14,00 |
| TK301005201  | AKIM TRAFOSU 100/5A, 30MM, SINIF 0.5, 1VA    | \$14,29 |
| TK301255201  | AKIM TRAFOSU 125/5A, 30MM, SINIF 0.5, 1VA    | \$15,00 |
| TK302005205  | AKIM TRAFOSU 200/5A, 30MM, SINIF 0.5, 5VA    | \$13,14 |
| TK302505205  | AKIM TRAFOSU 250/5A, 30MM, SINIF 0.5, 5VA    | \$13,14 |
| TK303005205  | AKIM TRAFOSU 300/5A, 30MM, SINIF 0.5, 5VA    | \$13,14 |
| TK304005205  | AKIM TRAFOSU 400/5A, 30MM, SINIF 0.5, 5VA    | \$13,14 |
| TK305005205  | AKIM TRAFOSU 500/5A, 30MM, SINIF 0.5, 5VA    | \$13,14 |
| TK306005205  | AKIM TRAFOSU 600/5A, 30MM, SINIF 0.5, 5VA    | \$13,14 |
| TK302505207  | AKIM TRAFOSU 250/5A, 30MM, SINIF 0.5, 10VA   | \$15,00 |
| TK303005207  | AKIM TRAFOSU 300/5A, 30MM, SINIF 0.5, 10VA   | \$14,50 |
| TK304005207  | AKIM TRAFOSU 400/5A, 30MM, SINIF 0.5, 10VA   | \$12,86 |
| TK305005207  | AKIM TRAFOSU 500/5A, 30MM, SINIF 0.5, 10VA   | \$12,86 |
| TK306005207  | AKIM TRAFOSU 600/5A, 30MM, SINIF 0.5, 10VA   | \$12,86 |
| TK30A755104  | AKIM TRAFOSU 75/5A, 30MM, SINIF 1, 3.75VA    | \$30,00 |
| TK30A805105  | AKIM TRAFOSU 80/5A, 30MM, SINIF 1, 5VA       | \$30,00 |
| TK30A1005204 | AKIM TRAFOSU 100/5A, 30MM, SINIF 0.5, 3.75VA | \$22,00 |
| TK30A1255205 | AKIM TRAFOSU 125/5A, 30MM, SINIF 0.5, 5VA    | \$22,00 |
| TK30A1505205 | AKIM TRAFOSU 150/5A, 30MM, SINIF 0.5, 5VA    | \$22,00 |
| TK30A1605205 | AKIM TRAFOSU 160/5A, 30MM, SINIF 0.5, 5VA    | \$22,00 |
| TK30A2005207 | AKIM TRAFOSU 200/5A, 30MM, SINIF 0.5, 10VA   | \$24,00 |
| TK402005203  | AKIM TRAFOSU 200/5A, 40MM, SINIF 0.5, 2.5VA  | \$13,00 |
| TK402505203  | AKIM TRAFOSU 250/5A, 40MM, SINIF 0.5, 2.5VA  | \$13,00 |
| TK403005203  | AKIM TRAFOSU 300/5A, 40MM, SINIF 0.5, 2.5VA  | \$13,00 |
| TK404005205  | AKIM TRAFOSU 400/5A, 40MM, SINIF 0.5, 5VA    | \$14,20 |
| TK405005205  | AKIM TRAFOSU 500/5A, 40MM, SINIF 0.5, 5VA    | \$14,20 |
| TK406005205  | AKIM TRAFOSU 600/5A, 40MM, SINIF 0.5, 5VA    | \$15,00 |
| TK404005207  | AKIM TRAFOSU 400/5A, 40MM, SINIF 0.5, 10VA   | \$16,00 |
| TK405005207  | AKIM TRAFOSU 500/5A, 40MM, SINIF 0.5, 10VA   | \$15,00 |
| TK406005207  | AKIM TRAFOSU 600/5A, 40MM, SINIF 0.5, 10VA   | \$15,00 |
| TK408005207  | AKIM TRAFOSU 800/5A, 40MM, SINIF 0.5, 10VA   | \$15,40 |

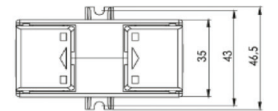
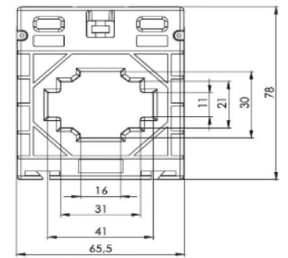
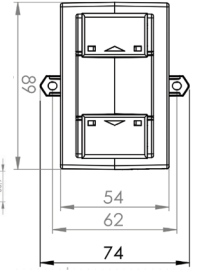
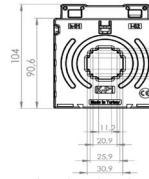
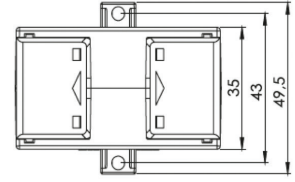
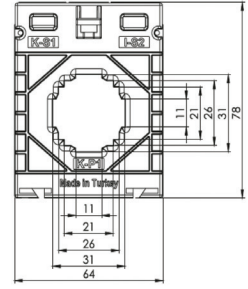



**FİYAT LİSTESİ**
**DELİKLİ TİP AKIM TRAFOSU**

| Model         | Özellikler  | Fiyat    | Resimler           |  |
|---------------|---|----------|--------------------|--|
| TK60D5005207  | DAR TIP AKIM TRAFOSU, 500/5A, 60MM, SINIF 0.5, 10VA         | \$19,23  | <p><b>YENİ</b></p> |  |
| TK60D6005209  | DAR TIP AKIM TRAFOSU, 600/5A, 60MM, SINIF 0.5, 15VA         | \$19,54  |                    |  |
| TK60D7505209  | DAR TIP AKIM TRAFOSU, 750/5A, 60MM, SINIF 0.5, 15VA         | \$22,26  |                    |  |
| TK60D8005209  | DAR TIP AKIM TRAFOSU, 800/5A, 60MM, SINIF 0.5, 15VA         | \$21,71  |                    |  |
| TK60D10005209 | DAR TIP AKIM TRAFOSU, 1000/5A, 60MM, SINIF 0.5, 15VA        | \$22,03  |                    |  |
| TK60D12005209 | DAR TIP AKIM TRAFOSU, 1200/5A, 60MM, SINIF 0.5, 15VA        | \$24,71  |                    |  |
| TK60D12505209 | DAR TIP AKIM TRAFOSU, 1250/5A, 60MM, SINIF 0.5, 15VA        | \$25,29  |                    |  |
| TK60D15005209 | DAR TIP AKIM TRAFOSU, 1500/5A, 60MM, SINIF 0.5, 15VA        | \$28,54  |                    |  |
| TK60D16005212 | DAR TIP AKIM TRAFOSU, 1600/5A, 60MM, SINIF 0.5, 30VA        | \$29,06  |                    |  |
| TK60D20005212 | DAR TIP AKIM TRAFOSU, 2000/5A, 60MM, SINIF 0.5, 30VA        | \$36,54  |                    |  |
| TK12020005212 | AKIM TRAFOSU 2000/5A, 120x70MM, SINIF 70MM, CLASS 0.5, 30VA | \$57,00  |                    |  |
| TK12025005212 | AKIM TRAFOSU 2500/5A, 120x70MM, SINIF 70MM, CLASS 0.5, 30VA | \$67,00  |                    |  |
| TK12030005212 | AKIM TRAFOSU 3000/5A, 120x70MM, SINIF 70MM, CLASS 0.5, 30VA | \$72,86  |                    |  |
| TK12032005212 | AKIM TRAFOSU 3200/5A, 120x70MM, SINIF 70MM, CLASS 0.5, 30VA | \$75,00  |                    |  |
| TK12040005212 | AKIM TRAFOSU 4000/5A, 120x70MM, SINIF 70MM, CLASS 0.5, 30VA | \$98,86  |                    |  |
| TK12050005212 | AKIM TRAFOSU 5000/5A, 120x70MM, SINIF 70MM, CLASS 0.5, 30VA | \$115,71 |                    |  |
| TK12060005212 | AKIM TRAFOSU 6000/5A, 120x70MM, SINIF 70MM, CLASS 0.5, 30VA | \$131,43 |                    |  |
| DK12512005209 | AKIM TRAFOSU 1200/5A, 125MM, SINIF 0.5, 15VA                | \$30,00  |                    |  |
| DK12512505209 | AKIM TRAFOSU 1250/5A, 125MM, SINIF 0.5, 15VA                | \$30,57  |                    |  |
| DK12515005212 | AKIM TRAFOSU 1500/5A, 125MM, SINIF 0.5, 30VA                | \$33,74  |                    |  |
| DK12516005212 | AKIM TRAFOSU 1600/5A, 125MM, SINIF 0.5, 30VA                | \$34,29  |                    |  |
| DK12520005212 | AKIM TRAFOSU 2000/5A, 125MM, SINIF 0.5, 30VA                | \$40,00  |                    |  |
| DK12525005212 | AKIM TRAFOSU 2500/5A, 125MM, SINIF 0.5, 30VA                | \$45,71  |                    |  |
| DK12530005212 | AKIM TRAFOSU 3000/5A, 125MM, SINIF 0.5, 30VA                | \$54,86  |                    |  |
| DK12532005212 | AKIM TRAFOSU 3200/5A, 125MM, SINIF 0.5, 30VA                | \$57,14  |                    |  |
| DK12540005212 | AKIM TRAFOSU 4000/5A, 125MM, SINIF 0.5, 30VA                | \$71,43  |                    |  |

**FİYAT LİSTESİ**
**AYRILABİLİR AKIM TRAFOLARI**

| AYRILABİLİR AKIM TRAFOLARI |   |          |
|----------------------------|---|----------|
| SK582505903                | Ayrılabilir Akım Trafosu 50x80mm 250/5A   | \$64,98  |
| SK583005903                | Ayrılabilir Akım Trafosu 50x80mm 300/5A   | \$64,98  |
| SK584005903                | Ayrılabilir Akım Trafosu 50x80mm 400/5A   | \$64,98  |
| SK585005903                | Ayrılabilir Akım Trafosu 50x80mm 500/5A   | \$64,98  |
| SK586005105                | Ayrılabilir Akım Trafosu 50x80mm 600/5A   | \$64,98  |
| SK587505105                | Ayrılabilir Akım Trafosu 50x80mm 750/5A   | \$64,98  |
| SK588005105                | Ayrılabilir Akım Trafosu 50x80mm 800/5A   | \$64,98  |
| SK5810005105               | Ayrılabilir Akım Trafosu 50x80mm 1000/5A  | \$64,98  |
| SK5812005105               | Ayrılabilir Akım Trafosu 50x80mm 1200/5A  | \$69,30  |
| SK5812505105               | Ayrılabilir Akım Trafosu 50x80mm 1250/5A  | \$69,30  |
| SK5815005105               | Ayrılabilir Akım Trafosu 50x80mm 1500/5A  | \$69,30  |
| SK5816005207               | Ayrılabilir Akım Trafosu 50x80mm 1600/5A  | \$69,30  |
| SK884005103                | Ayrılabilir Akım Trafosu 80x80mm 400/5A   | \$74,10  |
| SK885005103                | Ayrılabilir Akım Trafosu 80x80mm 500/5A   | \$74,10  |
| SK886005103                | Ayrılabilir Akım Trafosu 80x80mm 600/5A   | \$74,10  |
| SK887505105                | Ayrılabilir Akım Trafosu 80x80mm 750/5A   | \$74,10  |
| SK888005107                | Ayrılabilir Akım Trafosu 80x80mm 800/5A   | \$74,10  |
| SK8810005107               | Ayrılabilir Akım Trafosu 80x80mm 1000/5A  | \$74,10  |
| SK8812005107               | Ayrılabilir Akım Trafosu 80x80mm 1200/5A  | \$77,70  |
| SK8812505107               | Ayrılabilir Akım Trafosu 80x80mm 1250/5A  | \$77,70  |
| SK8815005107               | Ayrılabilir Akım Trafosu 80x80mm 1500/5A  | \$81,90  |
| SK8816005207               | Ayrılabilir Akım Trafosu 80x80mm 1600/5A  | \$81,90  |
| SK8820005207               | Ayrılabilir Akım Trafosu 80x80mm 2000/5A  | \$84,00  |
| SK8124005903               | Ayrılabilir Akım Trafosu 80x120mm 400/5A  | \$94,50  |
| SK8125005103               | Ayrılabilir Akım Trafosu 80x120mm 500/5A  | \$94,50  |
| SK8126005105               | Ayrılabilir Akım Trafosu 80x120mm 600/5A  | \$94,50  |
| SK8128005107               | Ayrılabilir Akım Trafosu 80x120mm 800/5A  | \$94,50  |
| SK81210005107              | Ayrılabilir Akım Trafosu 80x120mm 1000/5A | \$94,50  |
| SK81212005207              | Ayrılabilir Akım Trafosu 80x120mm 1200/5A | \$94,50  |
| SK81212505207              | Ayrılabilir Akım Trafosu 80x120mm 1250/5A | \$94,50  |
| SK81215005209              | Ayrılabilir Akım Trafosu 80x120mm 1500/5A | \$99,75  |
| SK81216005209              | Ayrılabilir Akım Trafosu 80x120mm 1600/5A | \$99,75  |
| SK81220005209              | Ayrılabilir Akım Trafosu 80x120mm 2000/5A | \$105,00 |
| SK81225005209              | Ayrılabilir Akım Trafosu 80x120mm 2500/5A | \$110,25 |
| SK81230005212              | Ayrılabilir Akım Trafosu 80x120mm 3000/5A | \$115,50 |

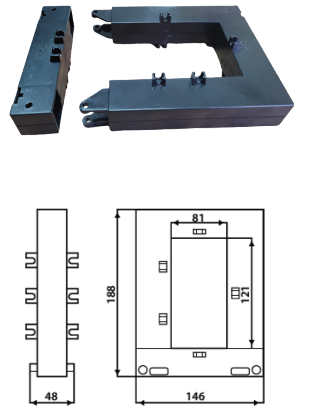
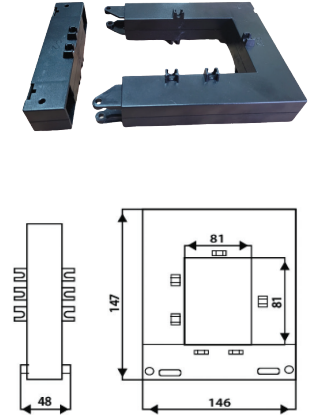
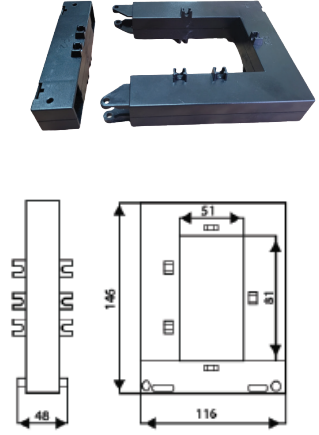

**AYRILABİLİR AKIM TRAFOLARI**

|               |   |          |  |  |
|---------------|---|----------|--|--|
| SK81610005207 | Ayrılabilir Akım Trafosu 80x160mm 1000/5A | \$171,00 |  |  |
| SK81612005207 | Ayrılabilir Akım Trafosu 80x160mm 1200/5A | \$171,00 |  |  |
| SK81612505207 | Ayrılabilir Akım Trafosu 80x160mm 1250/5A | \$171,00 |  |  |
| SK81615005209 | Ayrılabilir Akım Trafosu 80x160mm 1500/5A | \$171,00 |  |  |
| SK81616005209 | Ayrılabilir Akım Trafosu 80x160mm 1600/5A | \$171,00 |  |  |
| SK81620005209 | Ayrılabilir Akım Trafosu 80x160mm 2000/5A | \$182,40 |  |  |
| SK81625005209 | Ayrılabilir Akım Trafosu 80x160mm 2500/5A | \$193,80 |  |  |
| SK81630005212 | Ayrılabilir Akım Trafosu 80x160mm 3000/5A | \$199,50 |  |  |
| SK81640005212 | Ayrılabilir Akım Trafosu 80x160mm 4000/5A | \$205,20 |  |  |
| SK81650005212 | Ayrılabilir Akım Trafosu 80x160mm 5000/5A | \$216,60 |  |  |
| SK82020005207 | Ayrılabilir Akım Trafosu 80x200mm 2000/5A | \$229,95 |  |  |
| SK82025005209 | Ayrılabilir Akım Trafosu 80x200mm 2500/5A | \$233,10 |  |  |
| SK82030005209 | Ayrılabilir Akım Trafosu 80x200mm 3000/5A | \$236,25 |  |  |
| SK82040005212 | Ayrılabilir Akım Trafosu 80x200mm 4000/5A | \$241,50 |  |  |
| SK82050005212 | Ayrılabilir Akım Trafosu 80x200mm 5000/5A | \$246,75 |  |  |
| SK82060005212 | Ayrılabilir Akım Trafosu 80x200mm 6000/5A | \$262,50 |  |  |
| SK82063005212 | Ayrılabilir Akım Trafosu 80x200mm 6300/5A | \$273,00 |  |  |
| MSK241005901  | Ayrılabilir Akım Trafosu 24x24mm 100A/5A  | \$29,40  |  |  |
| MSK241255901  | Ayrılabilir Akım Trafosu 24x24mm 125A/5A  | \$29,40  |  |  |
| MSK241505902  | Ayrılabilir Akım Trafosu 24x24mm 150A/5A  | \$29,40  |  |  |
| MSK241605902  | Ayrılabilir Akım Trafosu 24x24mm 160A/5A  | \$29,40  |  |  |
| MSK242005903  | Ayrılabilir Akım Trafosu 24x24mm 200A/5A  | \$29,40  |  |  |
| MSK242505101  | Ayrılabilir Akım Trafosu 24x24mm 250A/5A  | \$29,40  |  |  |
| MSK243005101  | Ayrılabilir Akım Trafosu 24x24mm 300A/5A  | \$29,40  |  |  |
| MSK361005901  | Ayrılabilir Akım Trafosu 36x36mm 100A/5A  | \$34,65  |  |  |
| MSK361255901  | Ayrılabilir Akım Trafosu 36x36mm 125A/5A  | \$34,65  |  |  |
| MSK361505901  | Ayrılabilir Akım Trafosu 36x36mm 150A/5A  | \$34,65  |  |  |
| MSK361605901  | Ayrılabilir Akım Trafosu 36x36mm 160A/5A  | \$34,65  |  |  |
| MSK362005901  | Ayrılabilir Akım Trafosu 36x36mm 200A/5A  | \$34,65  |  |  |
| MSK362505903  | Ayrılabilir Akım Trafosu 36x36mm 250A/5A  | \$34,65  |  |  |
| MSK363005101  | Ayrılabilir Akım Trafosu 36x36mm 300A/5A  | \$34,65  |  |  |
| MSK364005102  | Ayrılabilir Akım Trafosu 36x36mm 400A/5A  | \$34,65  |  |  |
| MSK501505901  | Ayrılabilir Akım Trafosu 50x50mm 150A/5A  | \$46,20  |  |  |
| MSK501605901  | Ayrılabilir Akım Trafosu 50x50mm 160A/5A  | \$46,20  |  |  |
| MSK502005901  | Ayrılabilir Akım Trafosu 50x50mm 200A/5A  | \$46,20  |  |  |
| MSK502505901  | Ayrılabilir Akım Trafosu 50x50mm 250A/5A  | \$46,20  |  |  |
| MSK503005103  | Ayrılabilir Akım Trafosu 50x50mm 300A/5A  | \$46,20  |  |  |
| MSK504005103  | Ayrılabilir Akım Trafosu 50x50mm 400A/5A  | \$46,20  |  |  |
| MSK505005105  | Ayrılabilir Akım Trafosu 50x50mm 500A/5A  | \$47,25  |  |  |
| MSK506005105  | Ayrılabilir Akım Trafosu 50x50mm 600A/5A  | \$48,30  |  |  |
| MSK508005203  | Ayrılabilir Akım Trafosu 50x50mm 800A/5A  | \$49,35  |  |  |

**FIYAT LİSTESİ**
**BARALI AKIM TRAFOLARI**

| BARALI AKIM TRAFOLARI |  |         |
|-----------------------|--|---------|
| BK55205               | AKIM TRAFOSU, BARALI 5/5A, SINIF 0.5, 5VA    | \$25,71 |
| BK105205              | AKIM TRAFOSU, BARALI 10/5A, SINIF 0.5, 5VA   | \$21,43 |
| BK155205              | AKIM TRAFOSU, BARALI 15/5A, SINIF 0.5, 5VA   | \$21,43 |
| BK205205              | AKIM TRAFOSU, BARALI 20/5A, SINIF 0.5, 5VA   | \$21,43 |
| BK255205              | AKIM TRAFOSU, BARALI 25/5A, SINIF 0.5, 5VA   | \$21,43 |
| BK305205              | AKIM TRAFOSU, BARALI 30/5A, SINIF 0.5, 5VA   | \$21,43 |
| BK405205              | AKIM TRAFOSU, BARALI 40/5A, SINIF 0.5, 5VA   | \$22,86 |
| BK505205              | AKIM TRAFOSU, BARALI 50/5A, SINIF 0.5, 5VA   | \$23,71 |
| BK605205              | AKIM TRAFOSU, BARALI 60/5A, SINIF 0.5, 5VA   | \$23,71 |
| BK805205              | AKIM TRAFOSU, BARALI 80/5A, SINIF 0.5, 5VA   | \$23,71 |
| BK1005205             | AKIM TRAFOSU, BARALI 100/5A, SINIF 0.5, 5VA  | \$24,97 |
| BK1505205             | AKIM TRAFOSU, BARALI 150/5A, SINIF 0.5, 5VA  | \$23,71 |
| BK55207               | AKIM TRAFOSU, BARALI 5/5A, SINIF 0.5, 10VA   | \$23,71 |
| BK105207              | AKIM TRAFOSU, BARALI 10/5A, SINIF 0.5, 10VA  | \$23,71 |
| BK155207              | AKIM TRAFOSU, BARALI 15/5A, SINIF 0.5, 10VA  | \$23,71 |
| BK205207              | AKIM TRAFOSU, BARALI 20/5A, SINIF 0.5, 10VA  | \$23,71 |
| BK255207              | AKIM TRAFOSU, BARALI 25/5A, SINIF 0.5, 10VA  | \$23,71 |
| BK305207              | AKIM TRAFOSU, BARALI 30/5A, SINIF 0.5, 10VA  | \$23,71 |
| BK405207              | AKIM TRAFOSU, BARALI 40/5A, SINIF 0.5, 10VA  | \$24,29 |
| BK505207              | AKIM TRAFOSU, BARALI 50/5A, SINIF 0.5, 10VA  | \$25,43 |
| BK605207              | AKIM TRAFOSU, BARALI 60/5A, SINIF 0.5, 10VA  | \$25,43 |
| BK805207              | AKIM TRAFOSU, BARALI 80/5A, SINIF 0.5, 10VA  | \$25,43 |
| BK1005207             | AKIM TRAFOSU, BARALI 100/5A, SINIF 0.5, 10VA | \$25,73 |
| BK1505207             | AKIM TRAFOSU, BARALI 150/5A, SINIF 0.5, 10VA | \$25,43 |

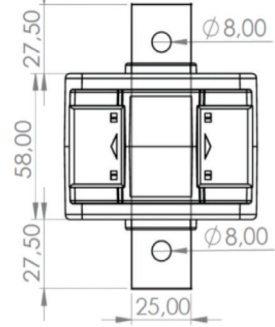
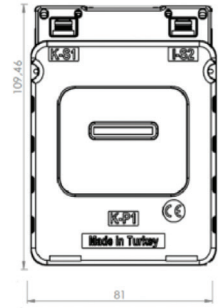
**FIYAT LİSTESİ**
**KAPALI TİP AKIM TRAFOLARI**

| KAPALI AKIM TRAFOLARI |   |         |
|-----------------------|---|---------|
| BK1C15101             | Kapalı Tip Akım Trafosu 1/5A, CLASS 1, 1VA      | \$21,00 |
| BK1C25101             | Kapalı Tip Akım Trafosu 2.5/5A, CLASS 1, 1VA    | \$21,00 |
| BK1C55101             | Kapalı Tip Akım Trafosu , 5/5A, CLASS 1, 1VA    | \$21,00 |
| BK1C105102            | Kapalı Tip Akım Trafosu , 10/5A, CLASS 1, 1.5VA | \$21,00 |
| BK1C155102            | Kapalı Tip Akım Trafosu, 15/5A, CLASS 1, 1.5VA  | \$21,00 |
| BK1C205102            | Kapalı Tip Akım Trafosu, 20/5A, CLASS 1, 1.5VA  | \$21,00 |
| BK1C255102            | Kapalı Tip Akım Trafosu, 25/5A, CLASS 1, 1.5VA  | \$21,00 |
| BK1C305201            | Kapalı Tip Akım Trafosu, 30/5A, CLASS 0.5, 1VA  | \$21,00 |
| BK1C405201            | Kapalı Tip Akım Trafosu 40/5A, CLASS 0.5, 1VA   | \$21,00 |
| BK1C505201            | Kapalı Tip Akım Trafosu, 50/5A, CLASS 0.5, 1VA  | \$21,00 |

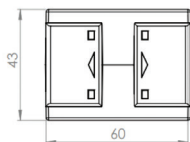
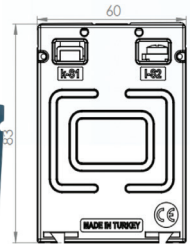

**FİYAT LİSTESİ**
**MÜHÜRLÜ AKIM TRAFOLARI**

| MÜHÜRLÜ AKIM TRAFOLARI |   |         |   |
|------------------------|---|---------|---|
| TK30A2005207-M         | AKIM TRAFOSU 200/5A, 30MM, SINIF 0.5, 10VA, MÜHÜRLÜ   | \$28,29 |    |
| TK302505207-M          | AKIM TRAFOSU 250/5A, 30MM, SINIF 0.5, 10VA, MÜHÜRLÜ   | \$18,86 |   |
| TK303005207-M          | AKIM TRAFOSU 300/5A, 30MM, SINIF 0.5, 10VA, MÜHÜRLÜ   | \$18,86 |   |
| TK304005207-M          | AKIM TRAFOSU 400/5A, 30MM, SINIF 0.5, 10VA, MÜHÜRLÜ   | \$16,29 |   |
| TK305005207-M          | AKIM TRAFOSU 500/5A, 30MM, SINIF 0.5, 10VA, MÜHÜRLÜ   | \$16,29 |   |
| TK306005207-M          | AKIM TRAFOSU 600/5A, 30MM, SINIF 0.5, 10VA, MÜHÜRLÜ   | \$16,29 |   |
| TK404005207-M          | AKIM TRAFOSU 400/5A, 40MM, SINIF 0.5, 10VA, MÜHÜRLÜ   | \$19,14 |   |
| TK405005207-M          | AKIM TRAFOSU 500/5A, 40MM, SINIF 0.5, 10VA, MÜHÜRLÜ   | \$18,57 |   |
| TK406005207-M          | AKIM TRAFOSU 600/5A, 40MM, SINIF 0.5, 10VA, MÜHÜRLÜ   | \$18,57 |   |
| TK408005207-M          | AKIM TRAFOSU 800/5A, 40MM, SINIF 0.5, 10VA, MÜHÜRLÜ   | \$18,57 |   |
| TK606005207-M          | AKIM TRAFOSU 600/5A, 60MM, SINIF 0.5, 10VA, MÜHÜRLÜ   | \$21,14 |   |
| TK608005207-M          | AKIM TRAFOSU 800/5A, 60MM, SINIF 0.5, 10VA, MÜHÜRLÜ   | \$22,86 |   |
| TK6010005207-M         | AKIM TRAFOSU 1000/5A, 60MM, SINIF 0.5, 10VA, MÜHÜRLÜ  | \$24,86 |   |
| TK6012005207-M         | AKIM TRAFOSU 1200/5A, 60MM, SINIF 0.5, 10VA, MÜHÜRLÜ  | \$26,29 |   |
| TK6012505207-M         | AKIM TRAFOSU 1250/5A, 60MM, SINIF 0.5, 10VA, MÜHÜRLÜ  | \$26,71 |  |
| TK8015005209-M         | AKIM TRAFOSU 1500/5A, 80MM, SINIF 0.5, 15VA, MÜHÜRLÜ  | \$32,29 |   |
| TK8016005209-M         | AKIM TRAFOSU 1600/5A, 80MM, SINIF 0.5, 15VA, MÜHÜRLÜ  | \$32,29 |   |
| TK10016005212-M        | AKIM TRAFOSU 1600/5A, 100MM, SINIF 0.5, 30VA, MÜHÜRLÜ | \$32,00 |   |
| TK10020005209-M        | AKIM TRAFOSU 2000/5A, 100MM, SINIF 0.5, 15VA, MÜHÜRLÜ | \$37,14 |   |
| TK10025005209-M        | AKIM TRAFOSU 2500/5A, 100MM, SINIF 0.5, 15VA, MÜHÜRLÜ | \$39,29 |   |
| TK10030005209-M        | AKIM TRAFOSU 3000/5A, 100MM, SINIF 0.5, 15VA, MÜHÜRLÜ | \$49,71 |   |
| TK10032005212-M        | AKIM TRAFOSU 3200/5A, 100MM, SINIF 0.5, 30VA, MÜHÜRLÜ | \$51,43 |   |
| TK10040005212-M        | AKIM TRAFOSU 4000/5A, 100MM, SINIF 0.5, 30VA, MÜHÜRLÜ | \$60,86 |   |
| BK55207-M              | AKIM TRAFOSU, BARALI 5/5A, SINIF 0.5, 10VA, MÜHÜRLÜ   | \$26,97 |   |
| BK105207-M             | AKIM TRAFOSU, BARALI 10/5A, SINIF 0.5, 10VA, MÜHÜRLÜ  | \$26,97 |   |
| BK155207-M             | AKIM TRAFOSU, BARALI 15/5A, SINIF 0.5, 10VA, MÜHÜRLÜ  | \$26,97 |   |
| BK205207-M             | AKIM TRAFOSU, BARALI 20/5A, SINIF 0.5, 10VA, MÜHÜRLÜ  | \$26,97 |   |
| BK255207-M             | AKIM TRAFOSU, BARALI 25/5A, SINIF 0.5, 10VA, MÜHÜRLÜ  | \$26,97 |   |
| BK305207-M             | AKIM TRAFOSU, BARALI 30/5A, SINIF 0.5, 10VA, MÜHÜRLÜ  | \$26,97 |   |
| BK405207-M             | AKIM TRAFOSU, BARALI 40/5A, SINIF 0.5, 10VA, MÜHÜRLÜ  | \$27,54 |   |
| BK505207-M             | AKIM TRAFOSU, BARALI 50/5A, SINIF 0.5, 10VA, MÜHÜRLÜ  | \$28,69 |   |
| BK605207-M             | AKIM TRAFOSU, BARALI 60/5A, SINIF 0.5, 10VA, MÜHÜRLÜ  | \$28,69 |   |
| BK805207-M             | AKIM TRAFOSU, BARALI 80/5A, SINIF 0.5, 10VA, MÜHÜRLÜ  | \$28,69 |   |
| BK1005207-M            | AKIM TRAFOSU, BARALI 100/5A, SINIF 0.5, 10VA, MÜHÜRLÜ | \$28,99 |   |
| BK1505207-M            | AKIM TRAFOSU, BARALI 150/5A, SINIF 0.5, 10VA, MÜHÜRLÜ | \$28,69 |   |



# RÖLE VE SOKETLER

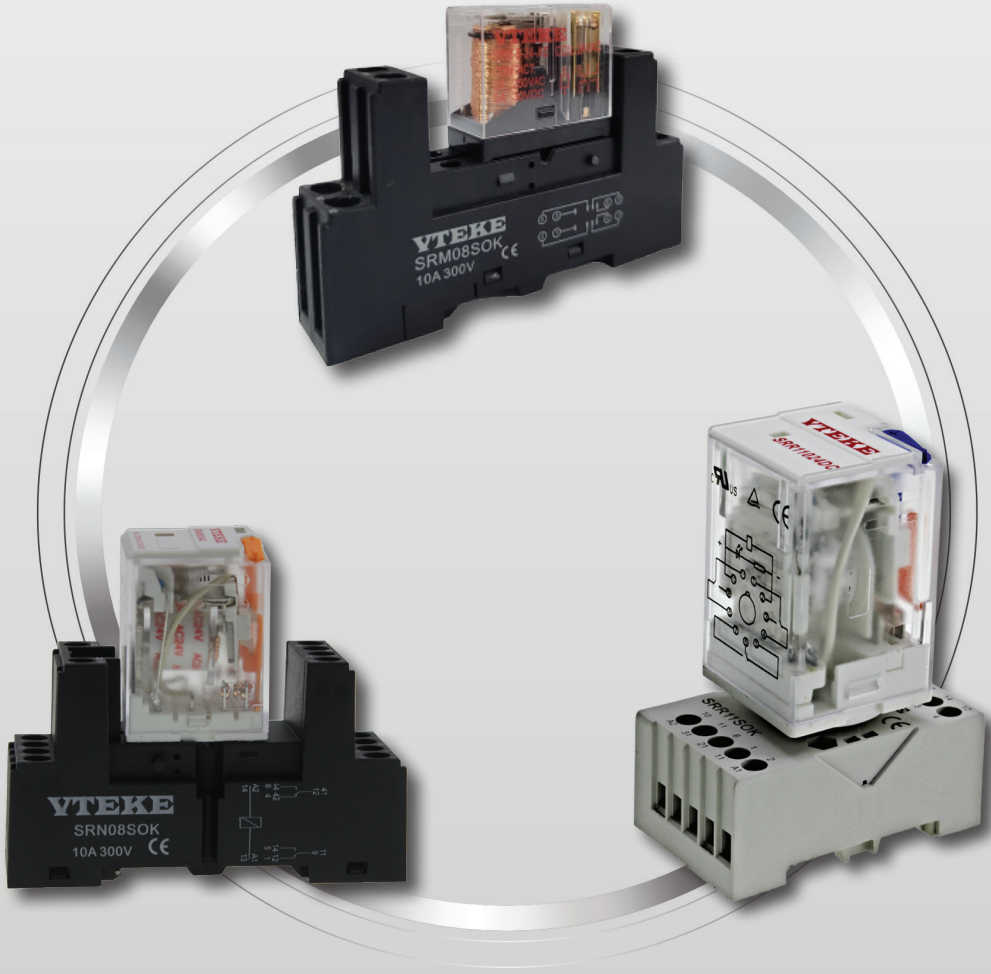

**VTEKE®**

**FİYAT LİSTESİ**
**RÖLELER VE RÖLE SOKETLERİ**

| SRM SERİSİ RÖLELER VE SOKETLER |   |        |
|--------------------------------|---|--------|
| SRM-8-012-AC                   | RÖLE 8PIN 2KONTAKT, 12VAC, 5A                     | \$4,40 |
| SRM-8-024-AC                   | RÖLE 8PIN 2KONTAKT, 24VAC, 5A                     | \$4,40 |
| SRM-8-048-AC                   | RÖLE 8PIN 2KONTAKT, 48VAC, 5A                     | \$5,86 |
| SRM-8-110-AC                   | RÖLE 8PIN 2KONTAKT, 110VAC, 5A                    | \$5,86 |
| SRM-8-230-AC                   | RÖLE 8PIN 2KONTAKT, 230VAC, 5A                    | \$5,86 |
| SRM-8-012-DC                   | RÖLE 8PIN 2KONTAKT, 12VDC, 5A                     | \$2,82 |
| SRM-8-024-DC                   | RÖLE 8PIN 2KONTAKT, 24VDC, 5A                     | \$2,82 |
| SRM-8-048-DC                   | RÖLE 8PIN 2KONTAKT, 48VDC, 5A                     | \$3,80 |
| SRM-8-110-DC                   | RÖLE 8PIN 2KONTAKT, 110VDC, 5A                    | \$4,05 |
| SRM-08-SOK                     | DÜZ SOKET 8 PİN SRM SERİSİ                        | \$3,15 |
| SRN SERİSİ RÖLELER VE SOKETLER |   |        |
| SRN-08-012-AC                  | RÖLE 8PIN 2KONTAKT, 12VAC,BAYRAKLI VE LEDLI, 5A   | \$5,43 |
| SRN-08-024-AC                  | RÖLE 8PIN 2KONTAKT, 24VAC,BAYRAKLI VE LEDLI, 5A   | \$5,43 |
| SRN-08-048-AC                  | RÖLE 8PIN 2KONTAKT, 48VAC,BAYRAKLI VE LEDLI, 5A   | \$5,43 |
| SRN-08-230-AC                  | RÖLE 8PIN 2KONTAKT, 230VAC,BAYRAKLI VE LEDLI, 5A  | \$5,43 |
| SRN-08-012-DC                  | RÖLE 8PIN 2KONTAKT, 12VDC,BAYRAKLI VE LEDLI, 5A   | \$5,43 |
| SRN-08-024-DC                  | RÖLE 8PIN 2KONTAKT, 24VDC, BAYRAKLI VE LEDLI, 5A  | \$5,43 |
| SRN-11-024-AC                  | RÖLE 11PIN 3KONTAKT, 24VAC,BAYRAKLI VE LEDLI, 5A  | \$5,43 |
| SRN-11-230-AC                  | RÖLE 11PIN 3KONTAKT, 230VAC,BAYRAKLI VE LEDLI, 5A | \$5,43 |
| SRN-11-012-DC                  | RÖLE 11PIN 3KONTAKT, 12VDC, BAYRAKLI VE LEDLI, 5A | \$5,43 |
| SRN-11-024-DC                  | RÖLE 11PIN 3KONTAKT, 24VDC,BAYRAKLI VE LEDLI, 5A  | \$5,43 |
| SRN-14-012-AC                  | RÖLE 14PIN 4KONTAKT, 12VAC,BAYRAKLI VE LEDLI, 5A  | \$5,43 |
| SRN-14-024-AC                  | RÖLE 14PIN 4KONTAKT, 24VAC,BAYRAKLI VE LEDLI, 5A  | \$5,43 |
| SRN-14-048-AC                  | RÖLE 14PIN 4KONTAKT, 48VAC,BAYRAKLI VE LEDLI, 5A  | \$5,43 |
| SRN-14-060-AC                  | RÖLE 14PIN 4KONTAKT, 60VAC,BAYRAKLI VE LEDLI, 5A  | \$5,43 |
| SRN-14-110-AC                  | RÖLE 14PIN 4KONTAKT, 110VAC,BAYRAKLI VE LEDLI, 5A | \$5,43 |
| SRN-14-230-AC                  | RÖLE 14PIN 4KONTAKT, 230VAC,BAYRAKLI VE LEDLI, 5A | \$5,43 |
| SRN-14-012-DC                  | RÖLE 14PIN 4KONTAKT, 12VDC,BAYRAKLI VE LEDLI, 5A  | \$5,43 |
| SRN-14-024-DC                  | RÖLE 14PIN 4KONTAKT, 24VDC,BAYRAKLI VE LEDLI, 5A  | \$5,43 |
| SRN-14-048-DC                  | RÖLE 14PIN 4KONTAKT, 48VDC,BAYRAKLI VE LEDLI, 5A  | \$5,43 |
| SRN-14-060-DC                  | RÖLE 14PIN 4KONTAKT, 60VDC,BAYRAKLI VE LEDLI, 5A  | \$5,43 |
| SRN-14-110-DC                  | RÖLE 14PIN 4KONTAKT, 110VDC,BAYRAKLI VE LEDLI, 5A | \$5,43 |
| SRN-08-SOK                     | DÜZ SOKET 8 PİN SRN SERİSİ                        | \$3,26 |
| SRN-11-SOK                     | DÜZ SOKET 11 PİN SRN SERİSİ                       | \$3,31 |
| SRN-14-SOK                     | DÜZ SOKET 14 PİN SRN SERİSİ                       | \$3,37 |



**SRR SERİSİ RÖLELER VE SOKETLER**

|               |  |         |
|---------------|--|---------|
| SRR-08-024-AC | RÖLE 8PIN 2KONTAKT, 24VAC (YUVARLAK SOKET TİPİ), 10A   | \$10,00 |
| SRR-08-230-AC | RÖLE 8PIN 2KONTAKT, 230VAC (YUVARLAK SOKET TİPİ), 10A  | \$10,00 |
| SRR-08-012-DC | RÖLE 8PIN 2KONTAKT, 12VDC (YUVARLAK SOKET TİPİ), 10A   | \$10,00 |
| SRR-08-024-DC | RÖLE 8PIN 2KONTAKT, 24VDC (YUVARLAK SOKET TİPİ), 10A   | \$10,00 |
| SRR-11-024-AC | RÖLE 11PIN 3KONTAKT, 24VAC (YUVARLAK SOKET TİPİ), 10A  | \$10,50 |
| SRR-11-230-AC | RÖLE 11PIN 3KONTAKT, 230VAC (YUVARLAK SOKET TİPİ), 10A | \$10,50 |
| SRR-11-012-DC | RÖLE 11PIN 3KONTAKT, 12VDC (YUVARLAK SOKET TİPİ), 10A  | \$10,50 |
| SRR-11-024-DC | RÖLE 11PIN 3KONTAKT, 24VDC (YUVARLAK SOKET TİPİ), 10A  | \$10,50 |
| SRR-11-048-DC | RÖLE 11PIN 3KONTAKT, 48VDC (YUVARLAK SOKET TİPİ), 10A  | \$10,50 |
| SRR-11-110-DC | RÖLE 11PIN 3KONTAKT, 110VDC (YUVARLAK SOKET TİPİ), 10A | \$10,50 |
| SRR-11-220-DC | RÖLE 11PIN 3KONTAKT, 220VDC (YUVARLAK SOKET TİPİ), 10A | \$13,50 |
| SRR-08-SOK    | YUVARLAK SOKET 8 PİN - SRR SERİSİ                      | \$3,26  |
| SRR-11-SOK    | YUVARLAK SOKET 11 PİN - SRR SERİSİ                     | \$3,31  |

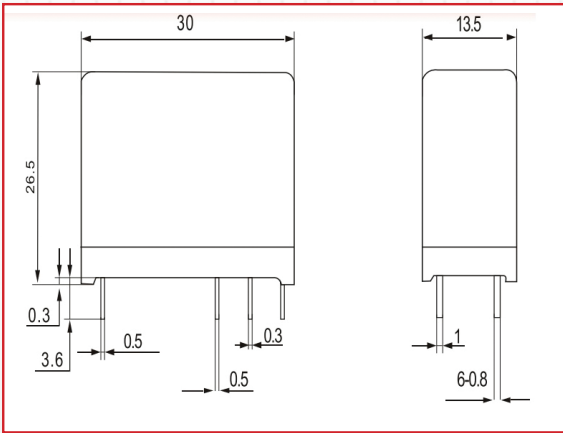
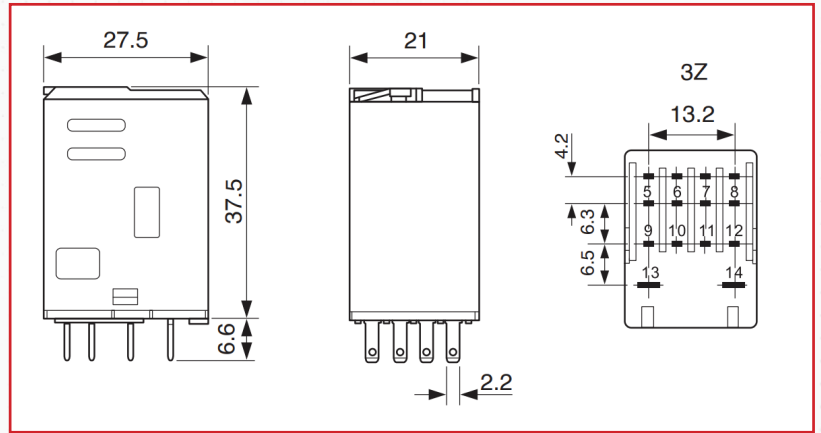
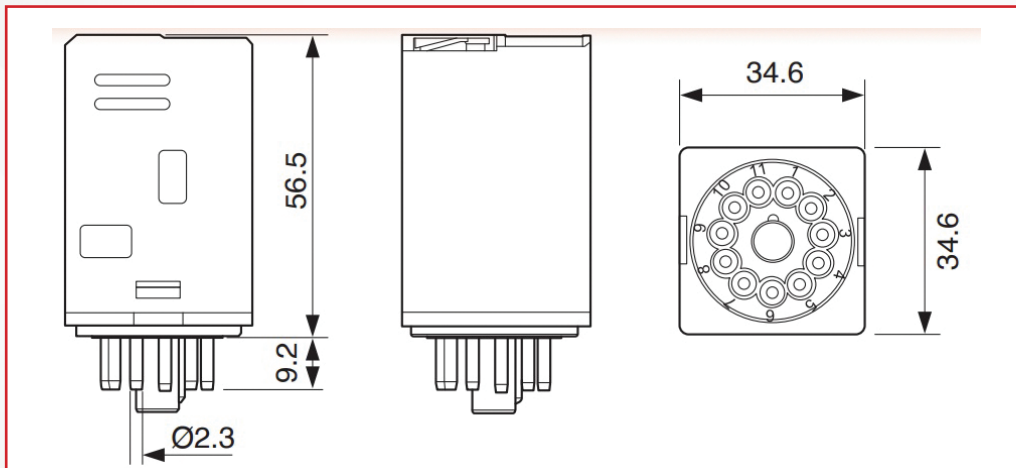
**SRM SERİSİ**

**SRN SERİSİ**

**SRR SERİSİ**

# SİLİNDİRİK SİGORTA YUVALARI VE BUŞONLARI



**VTEKE®**

**TEKNİK ÖZELLİKLER**

| PARAMETRE                            | FH-38                     | FH-51                     | FH-58                   |
|--------------------------------------|---------------------------|---------------------------|-------------------------|
| Anma Gerilimi                        | 690VAC                    | 690VAC                    | 690VAC                  |
| Kesme Kapasitesi                     | 50KA                      | 50KA                      | 100KA                   |
| Maks. Güç Kaybı                      | 3W Maks.                  | 5W Maks.                  | 9.5W Maks.              |
| Standart                             | IEC60269-2,<br>IEC60947-3 | IEC60269-2,<br>IEC60947-3 | IEC60947-3              |
| Kullanım Kategorisi                  | AC-22B                    | AC-22B                    | AC-22B                  |
| Yükselti                             | 2000m                     | 2000m                     | 2000m                   |
| Çalışma Sıcaklığı                    | -10°C - +50°C             | -10°C - +50°C             | -10°C - +50°C           |
| Kablo Kesiti                         | Maks. 25mm <sup>2</sup>   | Maks. 35mm <sup>2</sup>   | Maks. 50mm <sup>2</sup> |
| Tork                                 | 2-2.5Nm                   | 2.5-3Nm                   | 2.5-3Nm                 |
| Aleve Dayanıklılık<br>(IEC60695-2-1) | 960°C                     | 960°C                     | 960°C                   |
| Anma Darbe<br>Dayanma Gerilimi       | 6kV                       | 8kV                       | 8kV                     |

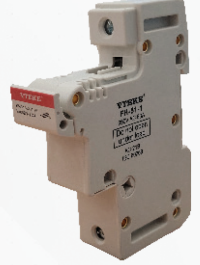

**TEKNİK ÖZELLİKLER**



| PARAMETRE                 | DEĞER   |
|---------------------------|---|
| Anma Gerilimi             | 500VAC  |
| Kesme Kapasitesi          | 100KA   |
| Anma Frekansı             | 45 - 62 Hz  |
| Güç Kaybı                 | Maks. 6W  |
| İşletme Sınıfı            | gG  |
| Standart                  | IEC60269-2  |
| Yükselti                  | 2000m   |
| Çalışma Sıcaklığı         | -10°C - +50°C, 48-85% RH                                      |
| Sigorta Gövdesi           | Seramik   |
| Kontaklar                 | CuZn37, Nikel Alaşımli Bakır/<br>5 Mikro Katman Gümüş Kaplama |
| Ark Söndürme<br>Materyali | Kuvarz Kumu   |
| Sigorta Elementi          | Bakır   |



| TİP   | ANMA AKIMI | ÇAP (A) | UZUNLUK (B) |
|-------|------------|---------|-------------|
| CFL38 | 0.5-32A    | 10.3±1  | 38±0.6      |
| CFL51 | 6-50A      | 14.3±1  | 51±0.6-1    |
| CFL58 | 16-25A     | 22.2±1  | 58±0.1-2    |

**FİYAT LİSTESİ**
**SİLİNDİRİK SİGORTA YUVALARI VE BUŞONLARI**

| SİLİNDİRİK KARTUŞ SİGORTA 10 X 38 |   |         |  |
|-----------------------------------|---|---------|--|
| FH-38-1                           | 1P 10 X 38 SİLİNDİRİK KARTUŞ SİGORTA YUVASI       | \$2,96  |   |
| FH-38-2                           | 2P 10 X 38 SİLİNDİRİK KARTUŞ SİGORTA YUVASI       | \$7,82  |  |
| FH-38-3                           | 3P 10 X 38 SİLİNDİRİK KARTUŞ SİGORTA YUVASI       | \$11,40 |  |
| FH-38-4                           | 4P 10 X 38 SİLİNDİRİK KARTUŞ SİGORTA YUVASI       | \$14,11 |  |
| FH-38D-1                          | 1P 10 X 38 LEDLİ SİLİNDİRİK KARTUŞ SİGORTA YUVASI | \$3,89  |  |
| CFL38005                          | SİLİNDİRİK KARTUŞ SİGORTA BUŞONU 10*38 0.5A       | \$0,80  |  |
| CFL38001                          | SİLİNDİRİK KARTUŞ SİGORTA BUŞONU 10*38 1A         | \$0,80  |  |
| CFL38002                          | SİLİNDİRİK KARTUŞ SİGORTA BUŞONU 10*38 2A         | \$0,80  |  |
| CFL38004                          | SİLİNDİRİK KARTUŞ SİGORTA BUŞONU 10*38 4A         | \$0,80  |  |
| CFL38006                          | SİLİNDİRİK KARTUŞ SİGORTA BUŞONU 10*38 6A         | \$0,80  |  |
| CFL38008                          | SİLİNDİRİK KARTUŞ SİGORTA BUŞONU 10*38 8A         | \$0,80  |  |
| CFL38010                          | SİLİNDİRİK KARTUŞ SİGORTA BUŞONU 10*38 10A        | \$0,80  |  |
| CFL38012                          | SİLİNDİRİK KARTUŞ SİGORTA BUŞONU 10*38 12A        | \$0,80  |  |
| CFL38016                          | SİLİNDİRİK KARTUŞ SİGORTA BUŞONU 10*38 16A        | \$0,80  |  |
| CFL38020                          | SİLİNDİRİK KARTUŞ SİGORTA BUŞONU 10*38 20A        | \$0,80  |  |
| CFL38025                          | SİLİNDİRİK KARTUŞ SİGORTA BUŞONU 10*38 25A        | \$0,80  |  |
| CFL38032                          | SİLİNDİRİK KARTUŞ SİGORTA BUŞONU 10*38 32A        | \$0,80  |  |

| SİLİNDİRİK KARTUŞ SİGORTA 14X51 |   |         |   |
|---------------------------------|---|---------|---|
| FH-51-1                         | 1P 14 X 51 SİLİNDİRİK KARTUŞ SİGORTA YUVASI | \$8,25  |  |
| FH-51-2                         | 2P 14 X 51 SİLİNDİRİK KARTUŞ SİGORTA YUVASI | \$18,78 |   |
| FH-51-3                         | 3P 14 X 51 SİLİNDİRİK KARTUŞ SİGORTA YUVASI | \$27,36 |   |
| CFL51006                        | SİLİNDİRİK KARTUŞ SİGORTA BUŞONU 14*51 6A   | \$1,40  |   |
| CFL51008                        | SİLİNDİRİK KARTUŞ SİGORTA BUŞONU 14*51 8A   | \$1,40  |  |
| CFL51010                        | SİLİNDİRİK KARTUŞ SİGORTA BUŞONU 14*51 10A  | \$1,40  |   |
| CFL51012                        | SİLİNDİRİK KARTUŞ SİGORTA BUŞONU 14*51 12A  | \$1,40  |   |
| CFL51016                        | SİLİNDİRİK KARTUŞ SİGORTA BUŞONU 14*51 16A  | \$1,40  |   |
| CFL51020                        | SİLİNDİRİK KARTUŞ SİGORTA BUŞONU 14*51 20A  | \$1,40  |   |
| CFL51025                        | SİLİNDİRİK KARTUŞ SİGORTA BUŞONU 14*51 25A  | \$1,40  |   |
| CFL51032                        | SİLİNDİRİK KARTUŞ SİGORTA BUŞONU 14*51 32A  | \$1,40  |   |
| CFL51040                        | SİLİNDİRİK KARTUŞ SİGORTA BUŞONU 14*51 40A  | \$1,40  |   |
| CFL51050                        | SİLİNDİRİK KARTUŞ SİGORTA BUŞONU 14*51 50A  | \$1,40  |   |
| CFL51063                        | SİLİNDİRİK KARTUŞ SİGORTA BUŞONU 14*51 63A  | \$1,40  |   |

**SİLİNDİRİK KARTUŞ SİGORTA 22X58**

|          |   |         |   |
|----------|---|---------|---|
| FH-58-1  | 1P 22 X 58 SİLİNDİRİK KARTUŞ SİGORTA YUVASI | \$11,00 |  |
| FH-58-2  | 2P 22 X 58 SİLİNDİRİK KARTUŞ SİGORTA YUVASI | \$26,00 |   |
| FH-58-3  | 3P 22 X 58 SİLİNDİRİK KARTUŞ SİGORTA YUVASI | \$42,00 |   |
| CFL58016 | SİLİNDİRİK KARTUŞ SİGORTA BUŞONU 22*58 16A  | \$2,80  |   |
| CFL58020 | SİLİNDİRİK KARTUŞ SİGORTA BUŞONU 22*58 20A  | \$2,80  |   |
| CFL58025 | SİLİNDİRİK KARTUŞ SİGORTA BUŞONU 22*58 25A  | \$2,80  |   |
| CFL58032 | SİLİNDİRİK KARTUŞ SİGORTA BUŞONU 22*58 32A  | \$2,80  |   |
| CFL58040 | SİLİNDİRİK KARTUŞ SİGORTA BUŞONU 22*58 40A  | \$2,80  |   |
| CFL58050 | SİLİNDİRİK KARTUŞ SİGORTA BUŞONU 22*58 50A  | \$2,80  |   |
| CFL58063 | SİLİNDİRİK KARTUŞ SİGORTA BUŞONU 22*58 63A  | \$2,80  |   |
| CFL58080 | SİLİNDİRİK KARTUŞ SİGORTA BUŞONU 22*58 80A  | \$2,80  |   |
| CFL58100 | SİLİNDİRİK KARTUŞ SİGORTA BUŞONU 22*58 100A | \$2,80  |   |
| CFL58125 | SİLİNDİRİK KARTUŞ SİGORTA BUŞONU 22*58 125A | \$2,80  |   |

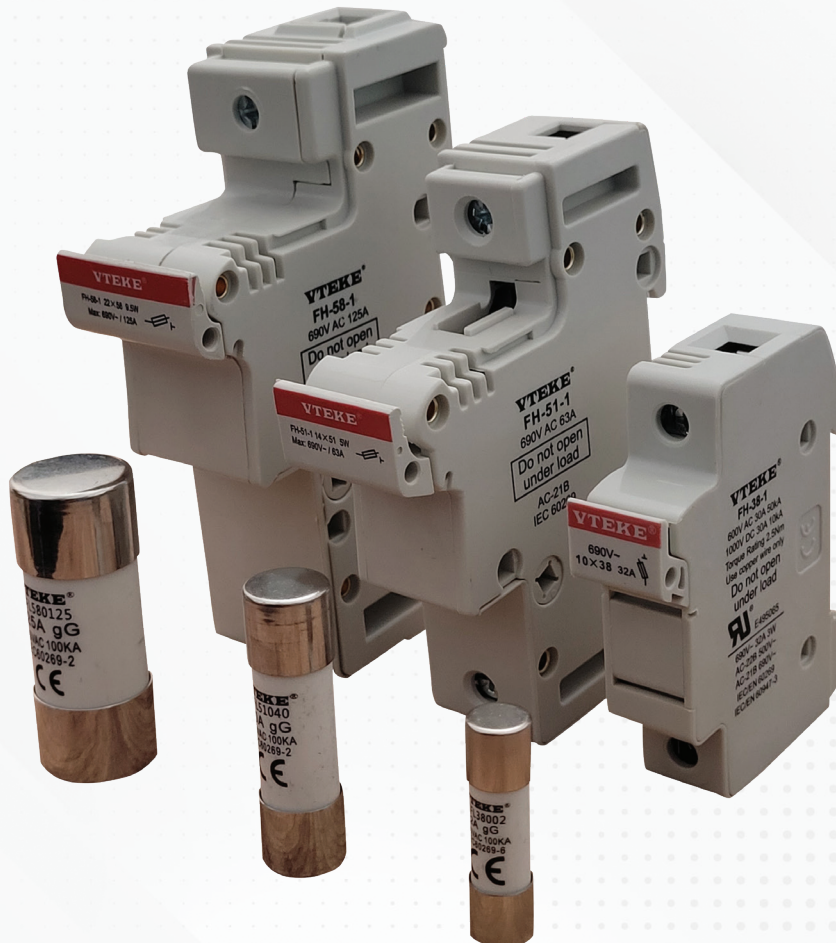

# ANALOG ÖLÇÜ ALETLERİ

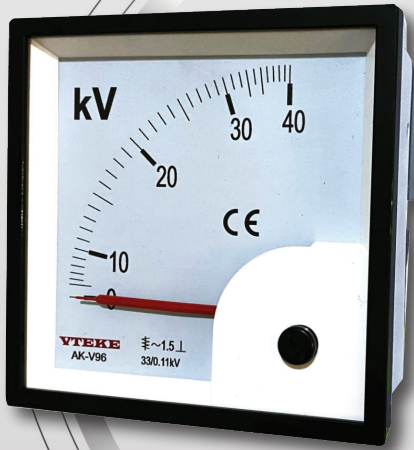

**VTEKE®**



**FİYAT LİSTESİ**
**VOLTMETRELER**

| VOLTMETRELER   |  |         |
|----------------|--|---------|
| AK-V72-500V    | ANALOG VOLTMETRE 72 X 72 500V            | \$17,64 |
| AK-V96-500V    | ANALOG VOLTMETRE 96 X 96 500V            | \$18,90 |
| AK-V72-XX/0.1  | OG ANALOG VOLTMETRE 72 X 72 (XX kV/100V) | \$21,06 |
| AK-V72-XX/0.11 | OG ANALOG VOLTMETRE 72 X 72 (XX kV/110V) | \$21,06 |
| AK-V72-XX/0.22 | OG ANALOG VOLTMETRE 72 X 72 (XX kV/220V) | \$21,06 |
| AK-V96-XX/0.1  | OG ANALOG VOLTMETRE 96 X 96 (XX kV/100V) | \$22,68 |
| AK-V96-XX/0.11 | OG ANALOG VOLTMETRE 96 X 96 (XX kV/110V) | \$22,68 |
| AK-V96-XX/0.22 | OG ANALOG VOLTMETRE 96 X 96 (XX kV/220V) | \$22,68 |

**FİYAT LİSTESİ**
**AMPERMETRELER**

| AMPERMETRELER |                                   |         |
|---------------|-----------------------------------|---------|
| AK-A72-5      | ANALOG AMPERMETRE 72 X 72, 5/5A   | \$15,96 |
| AK-A72-10     | ANALOG AMPERMETRE 72 X 72, 10/5A  | \$15,96 |
| AK-A72-15     | ANALOG AMPERMETRE 72 X 72, 15/5A  | \$15,96 |
| AK-A72-20     | ANALOG AMPERMETRE 72 X 72, 20/5A  | \$15,96 |
| AK-A72-25     | ANALOG AMPERMETRE 72 X 72, 25/5A  | \$15,96 |
| AK-A72-30     | ANALOG AMPERMETRE 72 X 72, 30/5A  | \$15,96 |
| AK-A72-40     | ANALOG AMPERMETRE 72 X 72, 40/5A  | \$15,96 |
| AK-A72-50     | ANALOG AMPERMETRE 72 X 72, 50/5A  | \$15,96 |
| AK-A72-60     | ANALOG AMPERMETRE 72 X 72, 60/5A  | \$15,96 |
| AK-A72-75     | ANALOG AMPERMETRE 72 X 72, 75/5A  | \$15,96 |
| AK-A72-80     | ANALOG AMPERMETRE 72 X 72, 80/5A  | \$15,96 |
| AK-A72-100    | ANALOG AMPERMETRE 72 X 72, 100/5A | \$15,96 |
| AK-A72-125    | ANALOG AMPERMETRE 72 X 72, 125/5A | \$15,96 |
| AK-A72-150    | ANALOG AMPERMETRE 72 X 72, 150/5A | \$15,96 |
| AK-A72-160    | ANALOG AMPERMETRE 72 X 72, 160/5A | \$15,96 |
| AK-A72-200    | ANALOG AMPERMETRE 72 X 72, 200/5A | \$15,96 |
| AK-A72-250    | ANALOG AMPERMETRE 72 X 72, 250/5A | \$15,96 |
| AK-A72-300    | ANALOG AMPERMETRE 72 X 72, 300/5A | \$15,96 |
| AK-A72-400    | ANALOG AMPERMETRE 72 X 72, 400/5A | \$15,96 |
| AK-A72-500    | ANALOG AMPERMETRE 72 X 72, 500/5A | \$15,96 |
| AK-A72-600    | ANALOG AMPERMETRE 72 X 72, 600/5A | \$15,96 |
| AK-A72-630    | ANALOG AMPERMETRE 72 X 72, 630/5A | \$15,96 |
| AK-A72-750    | ANALOG AMPERMETRE 72 X 72, 750/5A | \$15,96 |
| AK-A72-800    | ANALOG AMPERMETRE 72 X 72, 800/5A | \$15,96 |



## AMPERMETRELER

|             |                                    |         |
|-------------|------------------------------------|---------|
| AK-A72-1000 | ANALOG AMPERMETRE 72 X 72, 1000/5A | \$15,96 |
| AK-A72-1200 | ANALOG AMPERMETRE 72 X 72, 1200/5A | \$15,96 |
| AK-A72-1250 | ANALOG AMPERMETRE 72 X 72, 1250/5A | \$15,96 |
| AK-A72-1500 | ANALOG AMPERMETRE 72 X 72, 1500/5A | \$15,96 |
| AK-A72-1600 | ANALOG AMPERMETRE 72 X 72, 1600/5A | \$15,96 |
| AK-A72-2000 | ANALOG AMPERMETRE 72 X 72, 2000/5A | \$15,96 |
| AK-A72-2500 | ANALOG AMPERMETRE 72 X 72, 2500/5A | \$15,96 |
| AK-A72-3000 | ANALOG AMPERMETRE 72 X 72, 3000/5A | \$15,96 |
| AK-A72-3200 | ANALOG AMPERMETRE 72 X 72, 3200/5A | \$15,96 |
| AK-A72-4000 | ANALOG AMPERMETRE 72 X 72, 4000/5A | \$15,96 |
| AK-A72-5000 | ANALOG AMPERMETRE 72 X 72, 5000/5A | \$15,96 |
| AK-A72-6000 | ANALOG AMPERMETRE 72 X 72, 6000/5A | \$15,96 |
| AK-A72-6300 | ANALOG AMPERMETRE 72 X 72, 6300/5A | \$15,96 |
| AK-A96-5    | ANALOG AMPERMETRE 96 X 96, 5/5A    | \$17,67 |
| AK-A96-10   | ANALOG AMPERMETRE 96 X 96, 10/5A   | \$17,67 |
| AK-A96-15   | ANALOG AMPERMETRE 96 X 96, 15/5A   | \$17,67 |
| AK-A96-20   | ANALOG AMPERMETRE 96 X 96, 20/5A   | \$17,67 |
| AK-A96-25   | ANALOG AMPERMETRE 96 X 96, 25/5A   | \$17,67 |
| AK-A96-30   | ANALOG AMPERMETRE 96 X 96, 30/5A   | \$17,67 |
| AK-A96-40   | ANALOG AMPERMETRE 96 X 96, 40/5A   | \$17,67 |
| AK-A96-50   | ANALOG AMPERMETRE 96 X 96, 50/5A   | \$17,67 |
| AK-A96-60   | ANALOG AMPERMETRE 96 X 96, 60/5A   | \$17,67 |
| AK-A96-75   | ANALOG AMPERMETRE 96 X 96, 75/5A   | \$17,67 |
| AK-A96-80   | ANALOG AMPERMETRE 96 X 96, 80/5A   | \$17,67 |
| AK-A96-100  | ANALOG AMPERMETRE 96 X 96, 100/5A  | \$17,67 |
| AK-A96-125  | ANALOG AMPERMETRE 96 X 96, 125/5A  | \$17,67 |
| AK-A96-150  | ANALOG AMPERMETRE 96 X 96, 150/5A  | \$17,67 |
| AK-A96-160  | ANALOG AMPERMETRE 96 X 96, 160/5A  | \$17,67 |
| AK-A96-200  | ANALOG AMPERMETRE 96 X 96, 200/5A  | \$17,67 |
| AK-A96-250  | ANALOG AMPERMETRE 96 X 96, 250/5A  | \$17,67 |
| AK-A96-300  | ANALOG AMPERMETRE 96 X 96, 300/5A  | \$17,67 |
| AK-A96-400  | ANALOG AMPERMETRE 96 X 96, 400/5A  | \$17,67 |
| AK-A96-500  | ANALOG AMPERMETRE 96 X 96, 500/5A  | \$17,67 |
| AK-A96-600  | ANALOG AMPERMETRE 96 X 96, 600/5A  | \$17,67 |
| AK-A96-630  | ANALOG AMPERMETRE 96 X 96, 630/5A  | \$17,67 |
| AK-A96-750  | ANALOG AMPERMETRE 96 X 96, 750/5A  | \$17,67 |
| AK-A96-800  | ANALOG AMPERMETRE 96 X 96, 800/5A  | \$17,67 |
| AK-A96-1000 | ANALOG AMPERMETRE 96 X 96, 1000/5A | \$17,67 |
| AK-A96-1200 | ANALOG AMPERMETRE 96 X 96, 1200/5A | \$17,67 |
| AK-A96-1250 | ANALOG AMPERMETRE 96 X 96, 1250/5A | \$17,67 |
| AK-A96-1500 | ANALOG AMPERMETRE 96 X 96, 1500/5A | \$17,67 |
| AK-A96-1600 | ANALOG AMPERMETRE 96 X 96, 1600/5A | \$17,67 |
| AK-A96-2000 | ANALOG AMPERMETRE 96 X 96, 2000/5A | \$17,67 |
| AK-A96-2500 | ANALOG AMPERMETRE 96 X 96, 2500/5A | \$17,67 |



| AMPERMETRELER |                                    |         |
|---------------|------------------------------------|---------|
| AK-A96-3000   | ANALOG AMPERMETRE 96 X 96, 3000/5A | \$17,67 |
| AK-A96-3200   | ANALOG AMPERMETRE 96 X 96, 3200/5A | \$17,67 |
| AK-A96-4000   | ANALOG AMPERMETRE 96 X 96, 4000/5A | \$17,67 |
| AK-A96-5000   | ANALOG AMPERMETRE 96 X 96, 5000/5A | \$17,67 |
| AK-A96-6000   | ANALOG AMPERMETRE 96 X 96, 6000/5A | \$17,67 |
| AK-A96-6300   | ANALOG AMPERMETRE 96 X 96, 6300/5A | \$17,67 |



## FİYAT LİSTESİ

### DİREKT AMPERMETRELER

| DİREKT AMPERMETRELER |                                 |         |
|----------------------|---------------------------------|---------|
| AK-A72-10D           | DİREKT AMPERMETRE 72 X 72 10A   | \$17,67 |
| AK-A72-15D           | DİREKT AMPERMETRE 72 X 72 15A   | \$17,67 |
| AK-A72-20D           | DİREKT AMPERMETRE 72 X 72 20A   | \$17,67 |
| AK-A72-25D           | DİREKT AMPERMETRE 72 X 72 25A   | \$17,67 |
| AK-A72-30D           | DİREKT AMPERMETRE 72 X 72 30A   | \$17,67 |
| AK-A72-40D           | DİREKT AMPERMETRE 72 X 72 40A   | \$17,67 |
| AK-A72-50D           | DİREKT AMPERMETRE 72 X 72 50A   | \$17,67 |
| AK-A72-60D           | DİREKT AMPERMETRE 72 X 72 60A   | \$17,67 |
| AK-A72-75D           | DİREKT AMPERMETRE 72 X 72 75A   | \$17,67 |
| AK-A72-80D           | DİREKT AMPERMETRE 72 X 72 80A   | \$17,67 |
| AK-A72-100D          | DİREKT AMPERMETRE 72 X 72, 100A | \$18,24 |
| AK-A96-10D           | DİREKT AMPERMETRE 96 X 96 10A   | \$19,95 |
| AK-A96-15D           | DİREKT AMPERMETRE 96 X 96 15A   | \$19,95 |
| AK-A96-20D           | DİREKT AMPERMETRE 96 X 96 20A   | \$19,95 |
| AK-A96-25D           | DİREKT AMPERMETRE 96 X 96 25A   | \$19,95 |
| AK-A96-30D           | DİREKT AMPERMETRE 96 X 96 30A   | \$19,95 |
| AK-A96-40D           | DİREKT AMPERMETRE 96 X 96 40A   | \$19,95 |
| AK-A96-50D           | DİREKT AMPERMETRE 96 X 96 50A   | \$19,95 |
| AK-A96-60D           | DİREKT AMPERMETRE 96 X 96 60A   | \$19,95 |
| AK-A96-75D           | DİREKT AMPERMETRE 96 X 96 75A   | \$19,95 |
| AK-A96-80D           | DİREKT AMPERMETRE 96 X 96 80A   | \$19,95 |
| AK-A96-100D          | DİREKT AMPERMETRE 96 X 96, 100A | \$20,52 |



## FİYAT LİSTESİ

### FREKANSMETRELER

| FREKANSMETRELER |                                   |         |
|-----------------|-----------------------------------|---------|
| AK-F96          | ANALOG FREKANSMETRE 45-55Hz 96X96 | \$66,00 |
| AK-F72          | ANALOG FREKANSMETRE 45-55Hz 72X72 | \$63,00 |

**YENİ**

## FİYAT LİSTESİ

### KOMÜTATÖRLER

| KOMÜTATÖRLER |  |  |
|--------------|--|--|
| CAV16701     | VOLTMETRE KOMÜTATÖRÜ komütatörü (L-L & L-N) + 0, 7 POZ., 16A |  |
| CAV16403     | AMPERMETRE KOMÜTATÖRÜ 3+0 POZ., 16A                          |  |

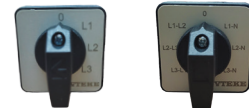

# CAM SİGORTALAR



**VTEKE®**

**FİYAT LİSTESİ**
**CAM SİGORTALAR**

| CAM SİGORTA 5X20 |                        |        |
|------------------|------------------------|--------|
| VGf-5-0.25       | Cam Sigorta 5x20 0.25A | \$0,05 |
| VGf-5-0.5        | Cam Sigorta 5x20 0.5A  | \$0,05 |
| VGf-5-1          | Cam Sigorta 5x20 1A    | \$0,05 |
| VGf-5-2          | Cam Sigorta 5x20 2A    | \$0,05 |
| VGf-5-2.5        | Cam Sigorta 5x20 2.5A  | \$0,05 |
| VGf-5-3.15       | Cam Sigorta 5x20 3.15A | \$0,05 |
| VGf-5-4          | Cam Sigorta 5x20 4A    | \$0,05 |
| VGf-5-5          | Cam Sigorta 5x20 5A    | \$0,05 |
| VGf-5-6          | Cam Sigorta 5x20 6A    | \$0,05 |
| VGf-5-8          | Cam Sigorta 5x20 8A    | \$0,05 |
| VGf-5-10         | Cam Sigorta 5x20 10A   | \$0,05 |
| VGf-5-15         | Cam Sigorta 5x20 15A   | \$0,05 |
| VGf-5-20         | Cam Sigorta 5x20 20A   | \$0,05 |
| VGf-5-25         | Cam Sigorta 5x20 25A   | \$0,05 |
| VGf-5-30         | Cam Sigorta 5x20 30A   | \$0,05 |



| CAM SİGORTA 6X30 |                      |        |
|------------------|----------------------|--------|
| VGf-6-1          | Cam Sigorta 6x30 1A  | \$0,06 |
| VGf-6-2          | Cam Sigorta 6x30 2A  | \$0,06 |
| VGf-6-3          | Cam Sigorta 6x30 3A  | \$0,06 |
| VGf-6-5          | Cam Sigorta 6x30 5A  | \$0,06 |
| VGf-6-8          | Cam Sigorta 6x30 8A  | \$0,06 |
| VGf-6-10         | Cam Sigorta 6x30 10A | \$0,06 |
| VGf-6-15         | Cam Sigorta 6x30 15A | \$0,06 |
| VGf-6-20         | Cam Sigorta 6x30 20A | \$0,06 |
| VGf-6-30         | Cam Sigorta 6x30 30A | \$0,06 |



| CAM SİGORTA YUVALARI |                                     |        |
|----------------------|-------------------------------------|--------|
| GFH-5                | Cam Sigorta Yuvası - Pano Tipi 5x20 | \$1,52 |
| GFH-6                | Cam Sigorta Yuvası - Pano Tipi 6x30 | \$2,17 |
| GFHC-5               | Cam Sigorta Yuvası - Kablolu 5x20   | \$0,65 |
| GFHC-6               | Cam Sigorta Yuvası - Kablolu 6x30   | \$0,76 |



# AKIM TRANSDÜSERİ

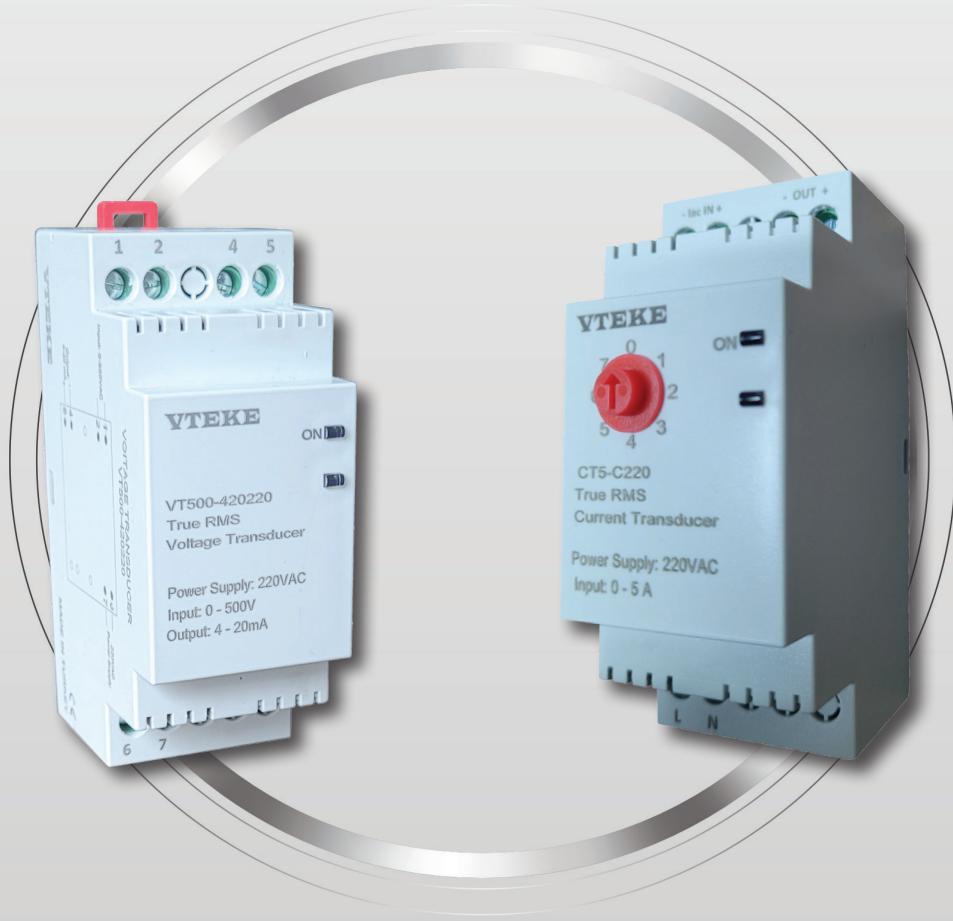

**VTEKE®**

**TEK FAZ TRANSDÜSER**

Kod : CT1-420220

XX XXX-XXX XXX

| Transedüser Tipi          | Giriş            | Çıkış             | Besleme Voltajı   |
|---------------------------|------------------|-------------------|-------------------|
| CT (Akım Transedüseri)    | • 1 (0-1AAC)     | • M (Seçilebilir) | • 24 (9-34VDC)    |
| VT (Gerilim Transedüseri) | • 5 (0-5AAC)     | • 420 (4-20mA)    | • 220 (85-280VAC) |
|                           | • 500 (0-500VAC) | • 020 (0-20mA)    |                   |
|                           | • 24 (0-24VAC)   | • 005 (0-5V)      |                   |
|                           | • İsteğe Göre    | • 010 (1-5V)      |                   |
|                           |                  | • 015 (1-5V)      |                   |
|                           |                  | • 210 (2-10V)     |                   |

**YENİ**
**FİYAT LİSTESİ**
**AKIM TRANSDÜSER**

| AKIM TRANSDÜSERİ (GİRİŞ 0-5A) |   |         |
|-------------------------------|---|---------|
| CT-5-M1-24                    | AKIM TRANSDÜSERİ, GİRİŞ:5A, ÇOKLU ÇIKIŞ, UN: 24V    | \$71,66 |
| CT-5-M1-220                   | AKIM TRANSDÜSERİ, GİRİŞ:5A, ÇOKLU ÇIKIŞ, UN:2204V   | \$80,34 |
| CT-5-42024                    | AKIM TRANSDÜSERİ, GİRİŞ:5A, ÇIKIŞ: 4-20MA, UN: 24V  | \$57,54 |
| CT-5-02024                    | AKIM TRANSDÜSERİ, GİRİŞ:5A, ÇIKIŞ: 0-20MA, UN: 24V  | \$57,54 |
| CT-5-00524                    | AKIM TRANSDÜSERİ, GİRİŞ:5A, ÇIKIŞ: 0-5V, UN: 24V    | \$57,54 |
| CT-5-01024                    | CUAKIM TRANSDÜSERİ, GİRİŞ:5A, ÇIKIŞ: 0-10V, UN: 24V | \$57,54 |
| CT-5-01524                    | AKIM TRANSDÜSERİ, GİRİŞ:5A, ÇIKIŞ: 1-5V, UN: 24V    | \$57,54 |
| CT-5-21024                    | AKIM TRANSDÜSERİ, GİRİŞ:5A, ÇIKIŞ: 2-10V, UN: 24V   | \$57,54 |
| CT-5-420220                   | AKIM TRANSDÜSERİ, GİRİŞ:5A, ÇIKIŞ: 4-20MA, UN: 220V | \$66,23 |
| CT-5-020220                   | AKIM TRANSDÜSERİ, GİRİŞ:5A, ÇIKIŞ: 0-20MA, UN: 220V | \$66,23 |
| CT-5-005220                   | AKIM TRANSDÜSERİ, GİRİŞ:5A, ÇIKIŞ: 0-5V, UN: 220V   | \$66,23 |
| CT-5-010220                   | AKIM TRANSDÜSERİ, GİRİŞ:5A, ÇIKIŞ: 0-10V, UN: 220V  | \$66,23 |
| CT-5-015220                   | AKIM TRANSDÜSERİ, GİRİŞ:5A, ÇIKIŞ: 1-5V, UN: 220V   | \$66,23 |
| CT-5-210220                   | AKIM TRANSDÜSERİ, GİRİŞ:5A, ÇIKIŞ: 2-10V, UN: 220V  | \$66,23 |
| AKIM TRANSDÜSERİ (GİRİŞ 0-1A) |   |         |
| CT-1-M1-24                    | AKIM TRANSDÜSERİ, GİRİŞ:1A, MULTİOUTPUT, UN: 24V    | \$71,66 |
| CT-1-M1-220                   | AKIM TRANSDÜSERİ, GİRİŞ:1A, MULTİOUTPUT, UN:220V    | \$80,34 |
| CT-1-42024                    | AKIM TRANSDÜSERİ, GİRİŞ:1A, ÇIKIŞ: 4-20MA, UN: 24V  | \$57,54 |
| CT-1-02024                    | AKIM TRANSDÜSERİ, GİRİŞ:1A, ÇIKIŞ: 0-20MA, UN: 24V  | \$57,54 |
| CT-1-00524                    | AKIM TRANSDÜSERİ, GİRİŞ:1A, ÇIKIŞ: 0-5V, UN: 24V    | \$57,54 |
| CT-1-01024                    | AKIM TRANSDÜSERİ, GİRİŞ:1A, ÇIKIŞ: 0-10V, UN: 24V   | \$57,54 |
| CT-1-01524                    | AKIM TRANSDÜSERİ, GİRİŞ:1A, ÇIKIŞ: 1-5V, UN: 24V    | \$57,54 |
| CT-1-21024                    | AKIM TRANSDÜSERİ, GİRİŞ:1A, ÇIKIŞ: 2-10V, UN: 24V   | \$57,54 |
| CT-1-420220                   | AKIM TRANSDÜSERİ, GİRİŞ:1A, ÇIKIŞ: 4-20MA, UN: 220V | \$66,23 |
| CT-1-020220                   | AKIM TRANSDÜSERİ, GİRİŞ:1A, ÇIKIŞ: 0-20MA, UN: 220V | \$66,23 |
| CT-1-005220                   | AKIM TRANSDÜSERİ, GİRİŞ:1A, ÇIKIŞ: 0-5V, UN: 220V   | \$66,23 |
| CT-1-010220                   | AKIM TRANSDÜSERİ, GİRİŞ:1A, ÇIKIŞ: 0-10V, UN: 220V  | \$66,23 |
| CT-1-015220                   | AKIM TRANSDÜSERİ, GİRİŞ:1A, ÇIKIŞ: 1-5V, UN: 220V   | \$66,23 |
| CT-1-210220                   | AKIM TRANSDÜSERİ, GİRİŞ:1A, ÇIKIŞ: 2-10V, UN: 220V  | \$66,23 |



# AKÜ ŞARJ ALETİ VE GÜÇ KAYNAKLARI

## FİYAT LİSTESİ

### AKÜ ŞARJ ALETİ

| AKÜ ŞARJ ALETİ |   |          |
|----------------|---|----------|
| VBC-05A        | AKÜ ŞARJ ALETİ 12/24V 5A 70W              | \$74,37  |
| VBC-1205       | AKÜ ŞARJ ALETİ 12V 5A 70W                 | \$62,97  |
| VBC-1210       | AKÜ ŞARJ ALETİ 12V 10A 140W               | \$67,31  |
| VBC-2405       | AKÜ ŞARJ ALETİ 24V 5A 140W                | \$65,14  |
| VBC-2410       | AKÜ ŞARJ ALETİ 24V 10A 275W               | \$141,14 |
| VBC-3002       | AKÜ ŞARJ ALETİ 30V 2.2A 70W               | \$65,72  |
| VBC-1205D      | AKÜ ŞARJ ALETİ 12V 5A 70W, RAYA MONTAJ    | \$65,83  |
| VBC-1210D      | AKÜ ŞARJ ALETİ 12V 10A 140W , RAYA MONTAJ | \$70,17  |
| VBC-2405D      | AKÜ ŞARJ ALETİ 24V 5A 140W, RAYA MONTAJ   | \$68,00  |
| VBC-2410D      | AKÜ ŞARJ ALETİ 24V 10A 275W, RAYA MONTAJ  | \$144,00 |
| VBC-3002D      | AKÜ ŞARJ ALETİ 30V 2.2A 70W , RAYA MONTAJ | \$68,58  |



## FİYAT LİSTESİ

### GÜÇ KAYNAKLARI

| GÜÇ KAYNAKLARI |                               |         |
|----------------|-------------------------------|---------|
| PSU-2403       | GÜÇ KAYNAĞI - RAY TİPİ 24V 3A | \$51,50 |
| PSU-2406       | GÜÇ KAYNAĞI - RAY TİPİ 24V 6A | \$77,00 |



**VTEKE®**



# DİJİTAL ÖLÇÜ ALETLERİ



**VTEKE®**



**FIYAT LİSTESİ**
**ŞEBEKE ANALİZÖRLERİ VE MULTİMETRELER**

| ŞEBEKE ANALİZÖRLERİ VE MULTİMETRELER |   |          |   |
|--------------------------------------|---|----------|---|
| EA-C1                                | Şebeke Analizörleri (2-31.Harmonik Ölçümü,RS-485 Haberleşmeli)                            | \$98,57  |    |
| EA-C4                                | Şebeke Analizörleri (2-31.Harmonik Ölçümü,RS-485 Haberleşmeli,Custom LCD)                 | \$157,71 |    |
| EA-C5                                | Şebeke Analizörleri (2-55.Harmonik Ölç,RS-485 Hab,2 Röle çıkışı,1 Dij. İntput,Custom LCD) | \$226,83 |    |
| VK-M96-C                             | LCD Ekran,Setli ve Haberleşmeli Multimetre (A,V,F,kW,kWh)                                 | \$106,45 |  |
| VK-M96                               | Multimetre 96x96 mm, (A,V,F, faz sıralı)  | \$53,23  |  |
| VK-M72                               | Multimetre 72X72 mm, (A,V,F, faz sıralı)  | \$53,23  |  |
| VK-M-250D                            | Direkt Multimetre 96x96 mm, (A,V,F, faz sıralı)   | \$76,22  |  |
| VK-M-DIN                             | Multimetre, W-otomat tipi   | \$61,11  |  |

**FİYAT LİSTESİ**
**DİJİTAL AMPERMETRELER**

| DİJİTAL AMPERMETRELER |   |         |   |
|-----------------------|---|---------|---|
| VK-A72                | Dijital Ampermetre 72X72                      | \$31,03 |    |
| VK-A96                | Dijital Ampermetre 96X96                      | \$31,03 |    |
| VK-A96-T              | 3-FAZ , Dijital Ampermetre 96X96              | \$50,27 |    |
| DC-A72                | Dijital DC Ampermetre 72X72                   | \$62,37 |  |
| VK-A72S               | Setli Dijital Ampermetre 72x72mm (150mA-995A) | \$50,00 |  |

**FİYAT LİSTESİ**
**DİJİTAL FREKANSMETRELER**

| DİJİTAL FREKANSMETRELER |   |         |   |
|-------------------------|---|---------|---|
| VK-F72                  | Dijital Frekansmetre 72x72mm (1- 400Hz) (15V - 500V AC) | \$31,54 |  |
| VK-F96                  | Dijital Frekansmetre 96x96mm (1- 400Hz) (15V - 500V AC) | \$31,54 |  |

**FİYAT LİSTESİ****DIJİTAL VOLTMETRELER**

| DİJİTAL VOLTMETRELER |   |         |   |
|----------------------|---|---------|---|
| VK-V72               | Dijital Voltmetre 72X72                     | \$27,60 |    |
| VK-V96               | Dijital Voltmetre 96X96                     | \$27,60 |    |
| VK-V72S              | 3 Fazlı Voltmetre 72X72 Seçmeli             | \$37,82 |  |
| VK-V96S              | 3 Fazlı Voltmetre 96X96 Seçmeli             | \$37,82 |  |
| VK-V96-T2            | Dijital 3 Faz Voltmetre 96x96mm (1-500V AC) | \$53,19 |  |
| DC-V72               | Dijital DC Voltmetre 72X72                  | \$52,68 |  |

# ZAMAN RÖLELERİ

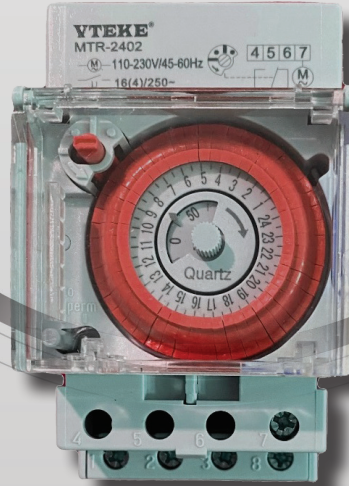
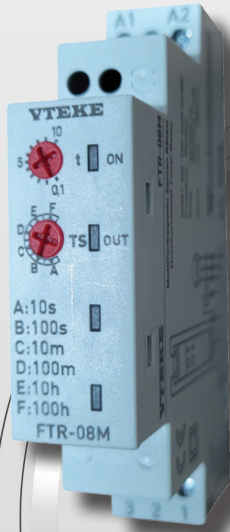





**VTEKE®**

**FIYAT LİSTESİ****ZAMAN RÖLELERİ**

| ZAMAN RÖLELERİ |  |         |   |
|----------------|--|---------|---|
| MTR-2401       | OTOMAT TİPİ MEKANİK ZAMAN SAATİ, 24SAAT, PİL100SAAT, MİN. 15DK | \$27,14 |    |
| MTR-2402       | OTOMAT TİPİ MEKANİK ZAMAN SAATİ, 24SAAT, PİL150SAAT, MİN. 30DK | \$30,00 |    |
| MTR-2403D      | OTOMAT TİPİ DİJİTAL ZAMAN SAATİ, 24SAAT                        | \$36,91 |   |
| DTR-30         | 0.1sn-30sn Zaman Rölesi  | \$15,49 |  |
| DTR-60         | 0.1sn-60sn Zaman Rölesi  | \$14,86 |  |
| DTR-60D        | 0.1sn-60sn Zaman Rölesi Bırakmada gecikmeli                    | \$14,86 |  |
| DTR-03M        | 0.1sn-3DK Zaman Rölesi   | \$15,78 |  |

**FİYAT LİSTESİ**
**ZAMAN RÖLELERİ**

| ZAMAN RÖLELERİ |   |         |   |
|----------------|---|---------|---|
| FTR-08         | 0.1sn-100 Saat Multifonksiyonlu Zaman Rölesi, 220VAC / 24VDC                      | \$19,31 |    |
| FTR-08D        | 0.1sn-100 Saat Multifonksiyonlu Zaman Rölesi, Bırakmada gecikmeli, 220VAC / 24VDC | \$19,31 |    |
| FTR-08M        | 0.1sn-100 Saat Multifonksiyonlu Zaman Rölesi(12-240V AC/DC)                       | \$24,45 |   |
| FTR-10         | Multifonksiyonlu Multi Timer (12-240V AC/DC) 10program                            | \$28,58 |  |
| FTR-09         | Multifonksiyonlu Flaşör Rölesi  | \$22,87 |  |
| FTR-07         | Multifonksiyonlu Sağ-Sol Rölesi   | \$23,66 |  |
| FTR-10D        | Zaman Rölesi çekmede - bırakmada gecikmeli 99dk                                   | \$31,43 |  |

# KUMANDA RÖLELERİ

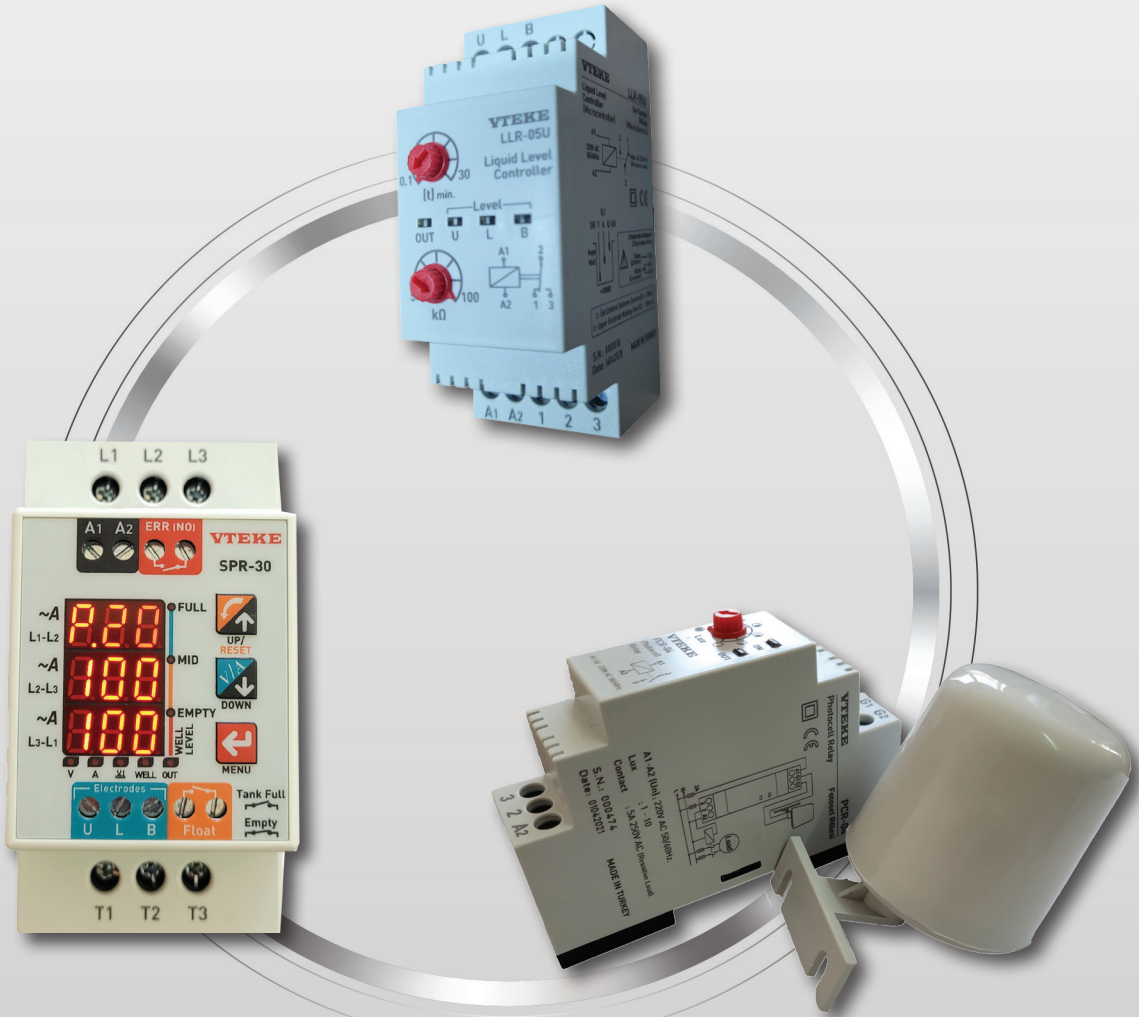

**VTEKE®**



**FİYAT LİSTESİ**
**KUMANDA RÖLELERİ**

| KUMANDA RÖLELERİ |   |         |   |
|------------------|---|---------|---|
| DTR-SD           | Yıldız-Üçgen Rölesi   | \$21,65 |    |
| DTR-SS           | Start-Stop rölesi   | \$21,68 |    |
| PCR-04           | Fotosel Rölesi, Lux Ayarlı  | \$17,31 |    |
| PCR-03           | Fotosel Rölesi, 10 Lux Sabit  | \$14,92 |   |
| HPM-02           | Hidrofor Sıralama Rölesi (3 kontaklı)   | \$27,64 |  |
| HPM-03           | Hidrofor Sıralama Rölesi (2 kontaklı)   | \$30,04 |  |
| SPR-30           | Dijital Kontaktörlü Trifaze Dalgıç Kontrol Rölesi (5.5kW'a kadar Direkt Çalışma) (150-270 V AC) | \$85,72 |  |
| LLR-05           | Hassasiyet Ayarlı Sıvı Seviye Rölesi  | \$19,72 |  |
| LLR-05U          | Hassasiyet Ayarlı ÜST ELEKTROD BEKLEME ZAMANLI Sıvı Seviye Rölesi                               | \$27,60 |  |
| LLE-10           | Sıvı Seviye Elektrodu   | \$4,29  |  |

# KORUMA RÖLELERİ



**VTEKE®**

**FİYAT LİSTESİ**
**KORUMA RÖLELERİ**

| KORUMA RÖLELERİ |   |          |   |
|-----------------|---|----------|---|
| DOR-25          | 0,1-25 A ARASI AYARLI,DİREKT BAĞLANTI ,DİJİTAL TERMİK RÖLESİ                                    | \$53,59  |    |
| DOR-50          | 15-50A A ARASI AYARLI,DİREKT BAĞLANTI ,DİJİTAL TERMİK RÖLESİ                                    | \$60,15  |    |
| DOR-100         | 40-100A ARASI AYARLI,AKIM TRAFOSU (K-L) BAĞLANTILI , DİJİTAL TERMİK RÖLESİ                      | \$69,75  |    |
| DOR-200         | 90-200A ARASI AYARLI,AKIM TRAFOSU (K-L) BAĞLANTILI , DİJİTAL TERMİK RÖLESİ                      | \$89,31  |   |
| DOR-400         | 290-400A ARASI AYARLI,AKIM TRAFOSU (K-L) BAĞLANTILI ,DİJİTAL TERMİK RÖLESİ                      | \$113,14 |  |
| PPR-14          | NÖTRLÜ Faz Sıralı Faz Koruma Rölesi,  | \$21,65  |  |
| PPR-24F         | NÖTRSÜZ Faz Sıralı Faz Koruma Rölesi, Aşırı-Düşük Gerilim koruma, Faz sarlı                     | \$25,35  |  |
| PPR-05F         | Faz Sıralı, Asimetri Ayarlı Faz Koruma Rölesi %5-%25, Aşırı-Düşük Gerilim koruma (3faz+nötr)    | \$25,63  |  |
| PPR-06F         | Faz Sıralı, Asimetri Ayarlı Faz Koruma Rölesi %5-%25, Aşırı-Düşük Gerilim koruma (3faz-nötrsüz) | \$25,63  |  |
| VCR-11          | Monofaze Aşırı-Düşük Gerilim Koruma Rölesi  | \$26,02  |  |

**FİYAT LİSTESİ**
**KORUMA RÖLELERİ**

| KORUMA RÖLELERİ |  |          |   |
|-----------------|--|----------|---|
| VCR-02F         | Aşırı-Düşük Ayarlı Faz Sıralı Trifaze Gerilim Kontrol Rölesi-Monofaz Kadran (3faz+nötr)    | \$26,02  |    |
| VCR-03F         | Aşırı-Düşük Ayarlı Faz Sıralı Trifaze Gerilim Kontrol Rölesi-Trifaze Kadran (3faz-Nötrsüz) | \$26,02  |    |
| VCR-12F         | Aşırı-Düşük Ayarlı Faz Sıralı Trifaze Gerilim Kontrol Rölesi-Monofaz Kadran (3faz+nötr)    | \$26,02  |    |
| DVC-04          | Trifaze Dijital Aşırı -Düşük Gerilim Kontrol Rölesi  | \$46,64  |  |
| DVC-01          | Monofaze Dijital Aşırı-Düşük Gerilim Kontrol Röles   | \$41,88  |  |
| CON-12          | Digital Kontaktör Termik (4 kW'a kadar), 12A   | \$55,95  |  |
| CON-18          | Digital Kontaktör Termik (7,5 kW'a kadar), 18A   | \$67,15  |  |
| CON-25          | Digital Kontaktör Termik (11 kW'a kadar), 25A  | \$71,60  |  |
| CON-50          | Digital Kontaktör Termik (22 kW'a kadar), 50A  | \$152,15 |  |
| VUC-01D         | Düşük Akım Kontrol Rölesi  | \$40,42  |  |

# BUTON SERİSİ VE AKSESUARLARI



**VTEKE®**

**FİYAT LİSTESİ****Ø 22 MM BUTON SERİSİ**

| PPB BUTON SERİSİ |   |        |  |
|------------------|---|--------|--|
| PPB-RG-12        | 22MM ON-OFF (YEŞİL-KIRMIZI) BUTON (NA+NK) | \$3,37 |  |
| PPB-EM-02        | 22MM KALICI MANTAR ACIL BUTON, 40MM       | \$2,55 |  |
| PPB-SE-01        | 22MM KALICI SEÇİCİ MANDAL BUTON 1-0       | \$2,19 |  |
| PPB-SE-11        | 22MM KALICI SEÇİCİ MANDAL BUTON 1-0-11    | \$2,87 |  |
| PPB-SP-01-G      | 22MM YAYLI BUTON YEŞİL, NA                | \$1,86 |  |
| PPB-SP-01-R      | 22MM YAYLI BUTON KIRMIZI, NK              | \$1,86 |  |
| PPB-SP-01-B      | 22MM YAYLI BUTON MAVİ, NA                 | \$1,86 |  |
| PPB-SP-01-BK     | 22MM YAYLI BUTON SİYAH, NA                | \$1,86 |  |
| PPB-SP-01-Y      | 22MM YAYLI BUTON SARI, NA                 | \$1,86 |  |
| PPB-CO-1         | 1 NA KONTAKT                              | \$0,85 |  |
| PPB-CO-2         | 1 NK KONTAKT                              | \$0,85 |  |

**FİYAT LİSTESİ**
**METAL BUTON SERİSİ**

| METAL BUTON SERİSİ |   |        |   |
|--------------------|---|--------|---|
| MPB-RG-12          | VİDA MONTAJLI, METAL SERİSİ 22MM ON-OFF (YEŞİL-KIRMIZI) BUTON (NA+NK) - | \$5,09 |    |
| MPB-EM-02          | VİDA MONTAJLI, METAL SERİSİ 22MM KALICI MANTAR ACIL BUTON, 40MM         | \$3,88 |    |
| MPB-SE-01          | VİDA MONTAJLI, METAL SERİSİ 22MM KALICI SEÇİCİ MANDAL BUTON 1-0         | \$3,09 |    |
| MPB-SE-11          | VİDA MONTAJLI, METAL SERİSİ 22MM KALICI SEÇİCİ MANDAL BUTON 1-0-11      | \$3,98 |   |
| MPB-SP-01-G        | VİDA MONTAJLI, METAL SERİSİ 22MM YAYLI BUTON YEŞİL, NA                  | \$2,66 |  |
| MPB-SP-01-R        | VİDA MONTAJLI, METAL SERİSİ 22MM YAYLI BUTON KIRMIZI, NK                | \$2,66 |   |
| MPB-SP-01-B        | VİDA MONTAJLI, METAL SERİSİ 22MM YAYLI BUTON MAVİ, NA                   | \$2,66 |   |
| MPB-SP-01-BK       | VİDA MONTAJLI, METAL SERİSİ 22MM YAYLI BUTON SİYAH, NA                  | \$2,66 |   |
| MPB-SP-01-Y        | VİDA MONTAJLI, METAL SERİSİ 22MM YAYLI BUTON SARI, NA                   | \$2,66 |   |

**FİYAT LİSTESİ****BUTON AKSESUARLARI**

| BUTON AKSESUARLARI |                                    |        |   |
|--------------------|------------------------------------|--------|---|
| PPA-101            | BUTON KORUMA KUTUSU - ŞEFFAF KAPAK | \$1,88 |    |
| PPA-102            | BUTON ÜST KORUMA -SARI             | \$2,19 |    |
| PPA-103            | BUTON 4LUK KORUMA -SARI            | \$1,52 |    |
| PPA-105            | ŞEFFAF SU GEÇİRMEZ KAPAK           | \$0,34 |   |
| PPA-104            | ACIL STOP ETİKETİ - SARI           | \$0,40 |  |
| MA-22-1            | 22MM Plastik Buton Rozeti          | \$0,13 |  |





**FİYAT LİSTESİ**
**Ø 22 MM SİNYAL LAMBALARI**
**Ø22 MM SİNYAL LAMBALARI**

|              |                                       |        |
|--------------|---------------------------------------|--------|
| SIL-22-220-G | LEDLİ SİNYAL LAMP 22MM 220VAC YEŞİL   | \$1,30 |
| SIL-22-220-R | LEDLİ SİNYAL LAMP 22MM 220VAC KIRMIIZ | \$1,30 |
| SIL-22-220-Y | LEDLİ SİNYAL LAMP 22MM 220VAC SARI    | \$1,30 |
| SIL-22-220-W | LEDLİ SİNYAL LAMP 22MM 220VAC BEYAZ   | \$1,30 |
| SIL-22-220-A | LEDLİ SİNYAL LAMP 22MM 220VAC TURUNCU | \$1,30 |
| SIL-22-220-B | LEDLİ SİNYAL LAMP 22MM 220VAC MAVİ    | \$1,30 |
| SIL-22-24-G  | LEDLİ SİNYAL LAMP 22MM 24VDC YEŞİL    | \$1,30 |
| SIL-22-24-R  | LEDLİ SİNYAL LAMP 22MM 24VDC KIRMIIZ  | \$1,30 |
| SIL-22-24-Y  | LEDLİ SİNYAL LAMP 22MM 24VDC SARI     | \$1,30 |
| SIL-22-24-W  | LEDLİ SİNYAL LAMP 22MM 24VDC BEYAZ    | \$1,30 |
| SIL-22-24-A  | LEDLİ SİNYAL LAMP 22MM 24VDC TURUNCU  | \$1,30 |
| SIL-22-24-B  | LEDLİ SİNYAL LAMP 22MM 24VDC MAVİ     | \$1,30 |
| SIL-22-110-G | LEDLİ SİNYAL LAMP 22MM 110VAC YEŞİL   | \$1,30 |
| SIL-22-110-R | LEDLİ SİNYAL LAMP 22MM 110VAC KIRMIIZ | \$1,30 |
| SIL-22-110-Y | LEDLİ SİNYAL LAMP 22MM 110VAC SARI    | \$1,30 |
| SIL-22-110-W | LEDLİ SİNYAL LAMP 22MM 110VAC BEYAZ   | \$1,30 |
| SIL-22-110-A | LEDLİ SİNYAL LAMP 22MM 110VAC TURUNCU | \$1,30 |
| SIL-22-110-B | LEDLİ SİNYAL LAMP 22MM 110VAC MAVİ    | \$1,30 |

**FİYAT LİSTESİ**
**VOLTMETRELER**
**VOLTMETRELER**

|          |  |        |
|----------|--|--------|
| VIL-22-G | 22MM VOLTMETRE (LEDLİ SİNYAL) YEŞİL    | \$3,22 |
| VIL-22-R | 22MM VOLTMETRE (LEDLİ SİNYAL) KIRMIIZI | \$3,22 |
| VIL-22-A | 22MM VOLTMETRE (LEDLİ SİNYAL) SARI     | \$3,22 |
| VIL-22-B | 22MM VOLTMETRE (LEDLİ SİNYAL) MAVİ     | \$3,37 |
| VIL-22-W | 22MM VOLTMETRE (LEDLİ SİNYAL) BEYAZ    | \$3,37 |

**FİYAT LİSTESİ**
**VOLTMETRE + AMPERMETRELER**
**VOLTMETRE + AMPERMETRE**

|          |  |        |
|----------|--|--------|
| AIL-22-G | 22MM AMPERMETRE+VOLTMETRE (LEDLİ SİNYAL) BEYAZ | \$8,40 |
| AIL-22-R | 22MM AMPERMETRE+VOLTMETRE (LEDLİ SİNYAL) BEYAZ | \$8,40 |
| AIL-22-A | 22MM AMPERMETRE+VOLTMETRE (LEDLİ SİNYAL) BEYAZ | \$8,40 |
| AIL-22-B | 22MM AMPERMETRE+VOLTMETRE (LEDLİ SİNYAL) BEYAZ | \$8,74 |
| AIL-22-W | 22MM AMPERMETRE+VOLTMETRE (LEDLİ SİNYAL) BEYAZ | \$8,74 |



**FİYAT LİSTESİ****BUZZERLAR**

| BUZZERLAR    |                                    |        |   |
|--------------|------------------------------------|--------|---|
| BIL-22-220-R | 22MM LEDLİ SİREN 220V KIRMIZI      | \$3,54 |  |
| BIL-22-24-R  | 22MM LEDLİ SİREN 24V AC/DC KIRMIZI | \$3,54 |   |

**FİYAT LİSTESİ****VİNÇ KUMANDALARI**

| VİNÇ KUMANDALARI |                                       |          |  |
|------------------|---------------------------------------|----------|--|
| VCC-2-1          | ACİL STOPLU VİNÇ KUMANDA 2+1 TEK HIZ  | \$20,09  |  |
| VCC-4-1          | ACİL STOPLU VİNÇ KUMANDA 2+1 TEK HIZ  | \$27,14  |  |
| VCC-6-1          | ACİL STOPLU VİNÇ KUMANDA 6+1 TEK HIZ  | \$36,70  |  |
| VCC-8-1          | ACİL STOPLU VİNÇ KUMANDA 8+1 TEK HIZ  | \$44,51  |  |
| VCC-2-2          | ACİL STOPLU VİNÇ KUMANDA 2+1 ÇİFT HIZ | \$30,40  |  |
| VCC-4-2          | ACİL STOPLU VİNÇ KUMANDA 4+1 ÇİFT HIZ | \$48,31  |  |
| VCC-6-2          | ACİL STOPLU VİNÇ KUMANDA 6+1 ÇİFT HIZ | \$65,14  |  |
| VCC-8-2          | ACİL STOPLU VİNÇ KUMANDA 8+1 ÇİFT HIZ | \$104,88 |  |

**FİYAT LİSTESİ****POTANSİYOMETRE**

| POTANSİYOMETRE |                             |        |   |
|----------------|-----------------------------|--------|---|
| PM-05          | 22MM POTANSİYOMETRE, 5KOHM  | \$7,06 |  |
| PM-10          | 22MM POTANSİYOMETRE, 10KOHM | \$7,06 |   |

# İŞ -GÜÇ ZAMAN SAATLERİ

## FİYAT LİSTESİ

### ZAMAN SAATLERİ

| ZAMAN SAATLERİ |                                   |         |
|----------------|-----------------------------------|---------|
| HM1-220-AC     | MEKANİK İŞ GÜÇ ZAMAN SAATİ 220VAC | \$14,79 |
| HM1-24-AC      | MEKANİK İŞ GÜÇ ZAMAN SAATİ 24VAC  | \$14,79 |
| HM1-110-AC     | MEKANİK İŞ GÜÇ ZAMAN SAATİ 110VAC | \$14,79 |
| HM1-48-AC      | MEKANİK İŞ GÜÇ ZAMAN SAATİ 48VAC  | \$14,79 |
| HM1-24-DC      | MEKANİK İŞ GÜÇ ZAMAN SAATİ 24VDC  | \$20,85 |
| OCM-220-AC     | MEKANİK DARBE SAYICI 220V         | \$18,83 |



## DİJİTAL İŞ GÜÇ ZAMAN SAATİ

# YAKINDA...

SERTİFİKALAR



TESLAB Elektrik Laboratuvarları Tic. Ltd. Şti. DENEY RAPORU TEST REPORT. Müşteri Adı/Adresi: VTEK ELEKTRİK İTH. İHR. SAN. VE TIC. LTD. ŞTİ. ...

TESLAB Elektrik Laboratuvarları Tic. Ltd. Şti. DENEY RAPORU TEST REPORT. Müşteri Adı/Adresi: VTEK ELEKTRİK İTH. İHR. SAN. VE TIC. LTD. ŞTİ. ...

TESLAB Elektrik Laboratuvarları Tic. Ltd. Şti. DENEY RAPORU TEST REPORT. Müşteri Adı/Adresi: VTEK ELEKTRİK İTH. İHR. SAN. VE TIC. LTD. ŞTİ. ...

TESLAB Elektrik Laboratuvarları Tic. Ltd. Şti. DENEY RAPORU TEST REPORT. Müşteri Adı/Adresi: VTEK ELEKTRİK İTH. İHR. SAN. VE TIC. LTD. ŞTİ. ...

TESLAB Elektrik Laboratuvarları Tic. Ltd. Şti. DENEY RAPORU TEST REPORT. Müşteri Adı/Adresi: VTEK ELEKTRİK İTH. İHR. SAN. VE TIC. LTD. ŞTİ. ...

TESLAB Elektrik Laboratuvarları Tic. Ltd. Şti. DENEY RAPORU TEST REPORT. Müşteri Adı/Adresi: VTEK ELEKTRİK İTH. İHR. SAN. VE TIC. LTD. ŞTİ. ...

TESLAB Elektrik Laboratuvarları Tic. Ltd. Şti. DENEY RAPORU TEST REPORT. Müşteri Adı/Adresi: VTEK ELEKTRİK İTH. İHR. SAN. VE TIC. LTD. ŞTİ. ...

TESLAB Elektrik Laboratuvarları Tic. Ltd. Şti. DENEY RAPORU TEST REPORT. Müşteri Adı/Adresi: VTEK ELEKTRİK İTH. İHR. SAN. VE TIC. LTD. ŞTİ. ...

TESLAB Elektrik Laboratuvarları Tic. Ltd. Şti. DENEY RAPORU TEST REPORT. Müşteri Adı/Adresi: VTEK ELEKTRİK İTH. İHR. SAN. VE TIC. LTD. ŞTİ. ...

testla Elektrik Laboratuvarları Tic. Ltd. Şti. DENEY RAPORU TEST REPORT. Müşteri Adı/Adresi: VTEK ELEKTRİK İTH. İHR. SAN. VE TIC. LTD. ŞTİ. ...

testla Elektrik Laboratuvarları Tic. Ltd. Şti. DENEY RAPORU TEST REPORT. Müşteri Adı/Adresi: VTEK ELEKTRİK İTH. İHR. SAN. VE TIC. LTD. ŞTİ. ...

Sertifika Certificate VTEK ELEKTRİK İTHALAT İHRACAT SANAYİ VE TİCARET LİMLERİ ŞİRKETİ. ISO 9001:2015. Müşteri Adı/Adresi: VTEK ELEKTRİK İTH. İHR. SAN. VE TIC. LTD. ŞTİ. ...



**REFERANSLAR****T.C. ADALET BAKANLIĞI****BOĞAZIÇI  
ELEKTRİK  
DAĞITIM****T.C. SAĞLIK BAKANLIĞI****ULUDAĞ  
ELEKTRİK  
DAĞITIM****T.C. ÇEVRE, ŞEHİRCİLİK VE İKLİM DEĞİŞİKLİĞİ BAKANLIĞI**  
**TOKİ**  
TOPLU KONUT İDARESİ BAŞKANLIĞI**AKDENİZ  
ELEKTRİK  
DAĞITIM****Toroslar****ÇAMLIBEL  
ELEKTRİK  
DAĞITIM****ARAS**  
Elektrik Dağıtım Anonim Şirketi

**YTEKE®**





**VTEKE®**

VTEK ELEKTRİK İTH. İHR. SAN. VE. TİC. LTD. ŞTİ.

Cumhuriyet Mah. Mücahit Sk. No:34-38-A  
İstanbul /Türkiye  
T : +90 212 544 00 04  
info@vteke.com.tr

www.vteke.com.tr



**expro**  
enerji

TÜRKİYE DİSTRİBÜTÖRÜ

İvedikosb Mah. 1463.Cad. No:24  
Yenimahalle/ANKARA/Türkiye  
T : +90 312 287 9776

www.exproenerji.com

